

**SPLIT TYPE  
ROOM AIR CONDITIONER  
WALL MOUNTED<sup>type</sup>  
INVERTER**

---

# **SERVICE INSTRUCTION**

<b>Models</b>	<b>Indoor unit</b>	<b>Outdoor unit</b>
	ASU 9RLF	AOU 9RLFW
	ASU12RLF	AOU12RLFW
	ASU15RLS	AOU15RLS

*Refrigerant*  
**R410A**

# CONTENTS

## 1. DESCRIPTION OF EACH CONTROL OPERATION

1. COOLING OPERATION.....	01-01
2. HEATING OPERATION.....	01-02
3. DRY OPERATION.....	01-02
4. AUTO CHANGEOVER OPERATION.....	01-03
5. INDOOR FAN CONTROL.....	01-04
6. OUTDOOR FAN CONTROL.....	01-06
7. LOUVER CONTROL.....	01-07
8. COMPRESSOR CONTROL.....	01-08
9. TIMER OPERATION CONTROL.....	01-09
10. ELECTRONIC EXPANSION VALVE CONTROL.....	01-11
11. TEST OPERATION CONTROL.....	01-11
12. PREVENT TO RESTART FOR 3 MINUTES ( 3 MINUTES ST ).....	01-11
13. FOUR-WAY VALVE EXTENSION SELECT.....	01-11
14. AUTO RESTART.....	01-11
15. MANUAL AUTO OPERATION ( Indoor unit body operation ).....	01-12
16. FORCED COOLING OPERATION.....	01-12
17. COMPRESSOR PREHEATING.....	01-12
18. MINIMUM HEAT OPERATION.....	01-12
19. ECONOMY OPERATION.....	01-12
20. DEFROST OPERATION CONTROL.....	01-13
21. OFF DEFROST OPERATION CONTROL.....	01-15
22. VARIOUS PROTECTIONS.....	01-16

## 2. TROUBLE SHOOTING

2-1 ERROR DISPLAY.....	02-01
2-1-1 WIRED REMOTE CONTROLLER DISPLAY (OPTION).....	02-01
2-1-2 OUTDOOR UNIT DISPLAY.....	02-02
2-1-3 INDOOR UNIT DISPLAY.....	02-03
2-2 TROUBLE SHOOTING WITH ERROR CODE.....	02-04
2-3 TROUBLE SHOOTING WITH NO ERROR CODE.....	02-24
2-4 SERVICE PARTS INFORMATION.....	02-29

## 3. APPENDING DATA

3-1 FUNCTION SETTING.....	03-01
3-1-1 INDOOR UNIT.....	03-01
3-1-2 Procedures to change the Function Setting for wireless RC.....	03-03
3-2 Thermistor Resistance Values.....	03-05
3-2-1 INDOOR UNIT.....	03-05
3-2-2 OUTDOOR UNIT.....	03-05

# ***WALL MOUNTED type INVERTER***

## **1 . DESCRIPTION OF EACH CONTROL OPERATION**

# 1. COOLING OPERATION

## 1-1 COOLING CAPACITY CONTROL

A sensor (room temperature thermistor) built in the indoor unit body will usually perceive difference or variation between a set temperature and present room temperature, and controls the operation frequency of the compressor.

- \* If the room temperature is 4°F(2°C) higher than a set temperature, the compressor operation frequency will attain to maximum performance.
- \* If the room temperature is 5°F(2.5°C) lower than a set temperature, the compressor will be stopped.
- \* When the room temperature is between +4°F(+2°C) to -5°F(-2.5°C) of the setting temperature, the compressor frequency is controlled within the range shown in Table1. However, the maximum frequency is limited in the range shown in Figure1 based on the fan speed mode and the outdoor temperature.

( Table1 : Compressor Frequency Range )

	minimum frequency	maximum frequency
ASU9RLF	22rps	79rps
ASU12RLF	18rps	96rps
ASU15RLS	15rps	80rps

( Fig.1 : Limit of Maximum Frequency based on Outdoor Temperature )

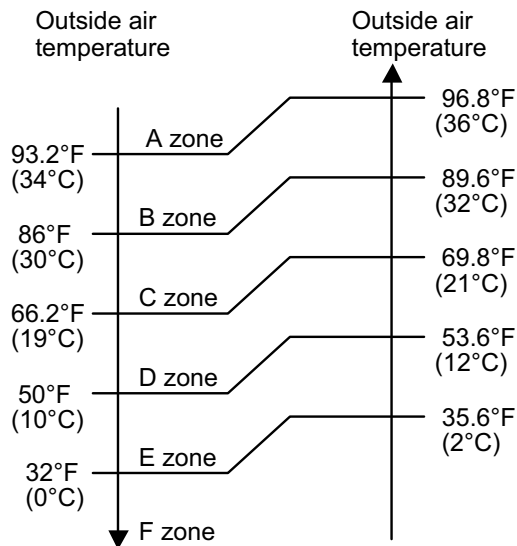

		Hi	Me	Lo	Quiet
9RLF	A zone	79rps	61rps	52rps	37rps
	B zone	79rps	61rps	52rps	37rps
	C zone	79rps	61rps	52rps	37rps
	D zone	52rps	43rps	37rps	28rps
	E zone	64rps	55rps	49rps	36rps
	F zone	64rps	55rps	49rps	36rps
12RLF	A zone	96rps	61rps	51rps	33rps
	B zone	96rps	61rps	51rps	33rps
	C zone	96rps	61rps	51rps	33rps
	D zone	57rps	42rps	36rps	27rps
	E zone	57rps	42rps	36rps	27rps
	F zone	57rps	42rps	36rps	27rps
15RLS	A zone	80rps	45rps	37rps	29rps
	B zone	80rps	45rps	37rps	29rps
	C zone	80rps	45rps	37rps	29rps
	D zone	47rps	37rps	31rps	22rps
	E zone	47rps	37rps	31rps	22rps
	F zone	47rps	37rps	31rps	22rps

## 2. HEATING OPERATION

### 2-1 HEATING CAPACITY CONTROL

A sensor (room temperature thermistor) built in the indoor unit body will usually perceive difference or variation between a set temperature and present room temperature, and controls the operation frequency of the compressor.

\* If the room temperature is lower by 6°F(3°C) than a set temperature, the compressor operation frequency will attain to maximum performance.

\* If the room temperature is higher 5°F(2.5°C) than a set temperature, the compressor will be stopped.

\* When the room temperature is between +5°F(+2.5°C) to -6°F(-3°C) of the setting temperature, the compressor frequency is controlled within the range shown in Table2.

( Table2 : Compressor Frequency Range )

	minimum frequency	maximum frequency
ASU9RLF	22rps	99rps
ASU12RLF	18rps	130rps
ASU15RLS	15rps	119rps

## 3. DRY OPERATION

### 3-1 INDOOR UNIT CONTROL

The compressor rotation frequency shall change according to the temperature, set temperature, and room temperature variation which the room temperature sensor of the indoor unit body has detected as shown in the Table3.

However, after the compressor is driven, the indoor unit shall run at operation frequency of 64rps (9RLF), 61rps (12RLF), 51rps (15RLS), for a minute.

( Table3 : Compressor frequency )

		Operating frequency			Operating frequency			Operating frequency
9RLF	X zone	37rps	12RLF	X zone	33rps	15RLS	X zone	29rps
	J zone	28rps		J zone	25rps		J zone	18rps
	Y zone	0rps		Y zone	0rps		Y zone	0rps

( Fig.2 : Compressor Control based on Room Temperature )

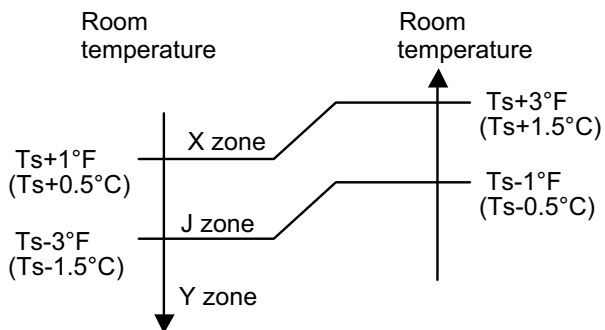

## 4. AUTO CHANGEOVER OPERATION

When the air conditioner is set to the AUTO mode by remote control, operation starts in the optimum mode from among the HEATING, COOLING, DRY and MONITORING modes. During operation, the optimum mode is automatically switched in accordance with temperature changes. The temperature can be set between 64°F(18°C) and 88°F(30°C) in 2°F(1°C) steps.

Operation flow chart

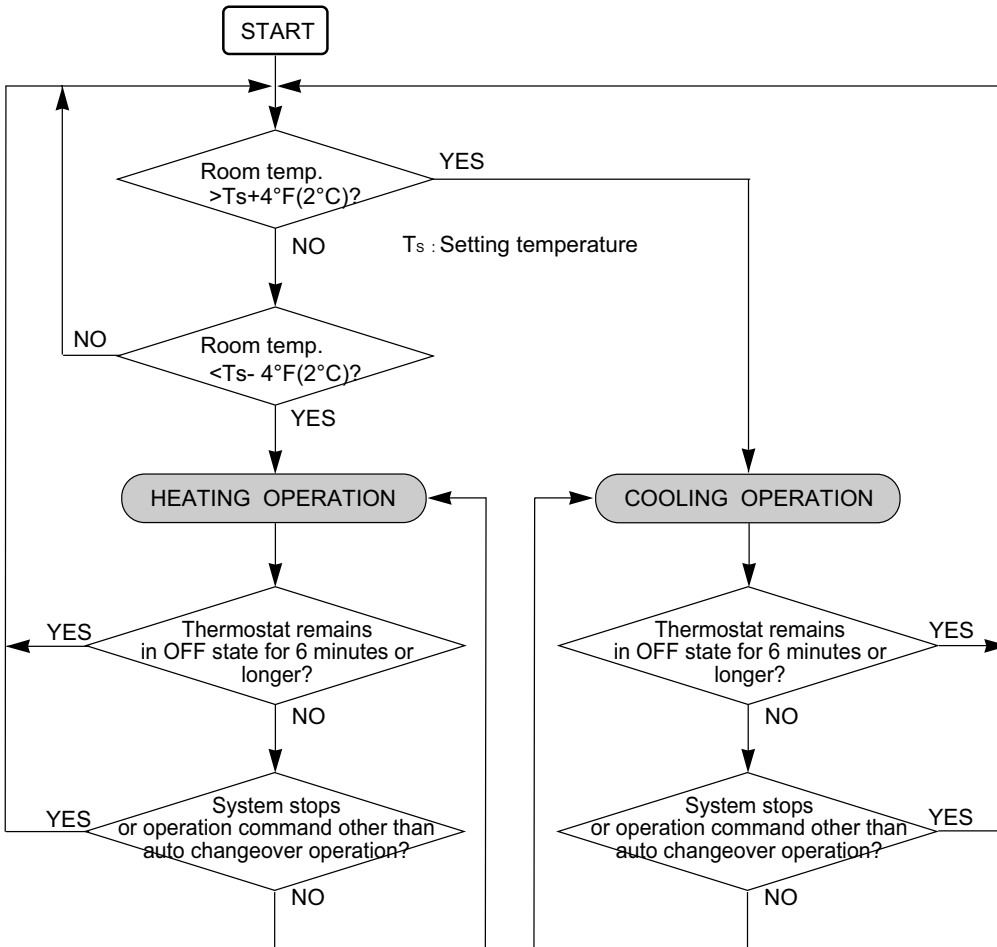

# 5. INDOOR FAN CONTROL

## 1. Fan speed

( Table4 : Indoor Fan Speed )

Operation mode	Air flow mode	Speed (rpm)		
		ASU9RLF	ASU12RLF	ASU15RLS
Heating	Hi	1330		1500
	Me+	1290		1360
	Me	1160		1230
	Lo	980		1050
	Quiet	710		770
	Cool air prevention	600		600
	S-Lo	480		480
Cooling/ Fan	Hi	1330		1440
	Me	1160		1230
	Lo	930		1000
	Quiet	680		750
Dry		X zone: 680 J zone: 660		X zone: 750 J zone: 730

## 2. FAN OPERATION

The airflow can be switched in 5 steps such as AUTO, QUIET, LOW, MED, HIGH, while the indoor fan only runs.

When Fan mode is set at (Auto), it operates on (MED) Fan Speed.

## 3. COOLING OPERATION

Switch the airflow [AUTO], and the indoor fan motor will run according to a room temperature, as shown in Figure3.

On the other hand, if switched in [HIGH]~[QUIET], the indoor motor will run at a constant airflow of [COOL] operation modes QUIET, LOW, MED, HIGH, as shown in Table4.

( Fig.3 : Airflow change - over ( Cooling : AUTO ) )

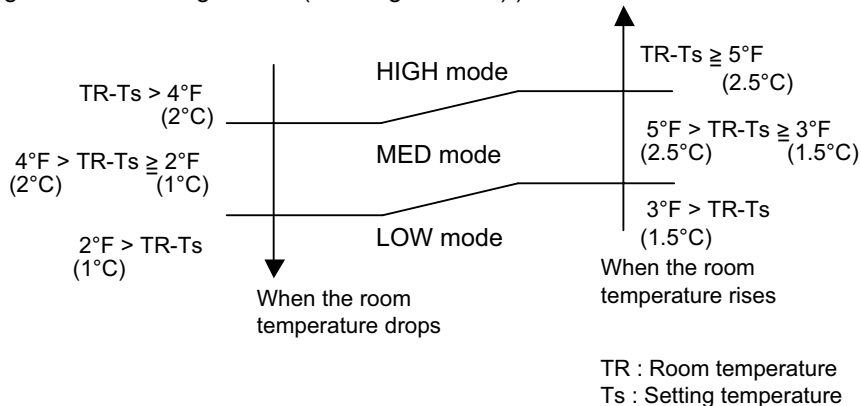

## 4. DRY OPERATION

Refer to the Table4.

During the dry mode operation, the fan speed setting can not be changed.

## 5. HEATING OPERATION

Switch the airflow [AUTO], and the indoor fan motor will run according to a room temperature, as shown in Figure4.

On the other hand, if switched in [HIGH] ~ [QUIET], the indoor motor will run at a constant airflow of [HEAT] operation modes QUIET, LOW, MED, HIGH, as shown in Table4.

( Fig.4 : Airflow change - over ( Heating : AUTO ) )

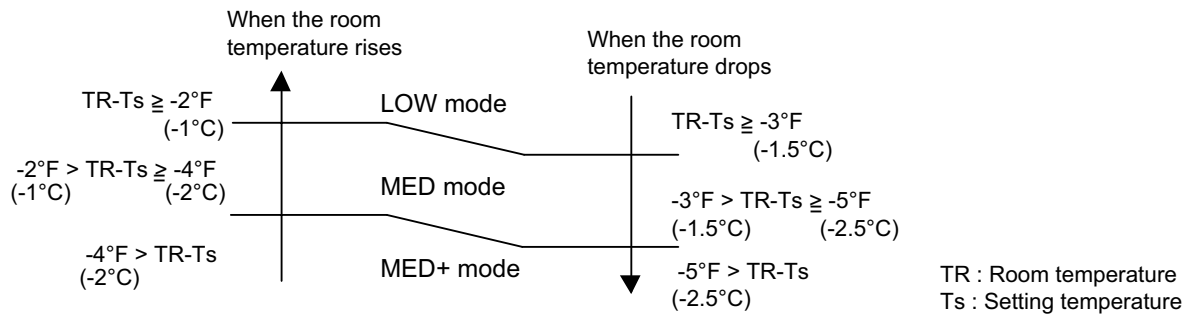

## 6. COOL AIR PREVENTION CONTROL (Heating mode)

The maximum value of the indoor fan speed is set as shown in Figure5, based on the detected temperature by the indoor heat exchanger sensor on heating mode.

(Fig.5 : Cool Air Prevention Control)

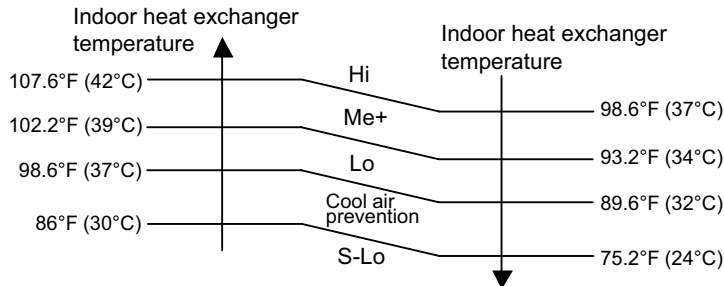

## 7. MOISTURE RETURN PREVENTION CONTROL (Cooling mode & Dry mode)

Switch the airflow [AUTO] at cooling mode, and the indoor fan motor will run as shown in Figure6.

( Fig.6 : Indoor Fan Control )

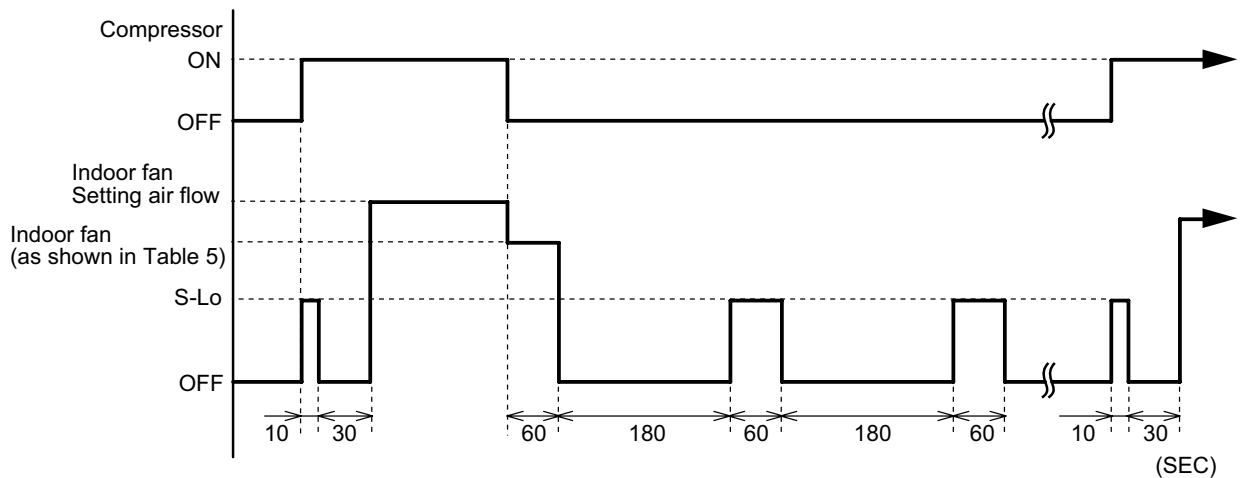

( Table5 : Indoor fan speed )

	Dry			Cooling
	X zone	J zone	Y zone	
ASU9/ 12RLF	680rpm	660rpm	0⇔480rpm	480rpm
ASU15RLS	750rpm	730rpm	0⇔480rpm	480rpm



## 6. OUTDOOR FAN CONTROL

### 1. Outdoor Fan Motor

Following table shows the type of the outdoor fan motor. The control method is different between AC motor and DC motor.

( Table6 : Type of Motor )

	AC Motor	DC Motor
ASU9/ 12RLF,15RLS		○

### 2. Fan Speed

( Table7 : Outdoor fan speed )

	Zone ※	Cooling	Heating	Dry
ASU9RLF	Y	860/ 780/ 760/ 470	900/ 760/ 720/ 680/ 470	760/ 470
	Z	860/ 470/ 330		
	F	230		
	G	150		
ASU12RLF	Y	850/ 750/ 670/ 500	950/ 850/ 750/ 680/ 550/ 450	760/ 470
	Z	850/ 500/ 350		
	F	330		
	G	230		
ASU15RLS	Y	1050/ 1010/ 870/ 720/ 530	1100/ 850/ 780/ 590/ 480	530
	Z	870/ 530/ 300		
	F	300/ 250		
	G	250/ 200		

※ Refer to Fig.7

( Fig.7 : Outside air temperature zone selection )

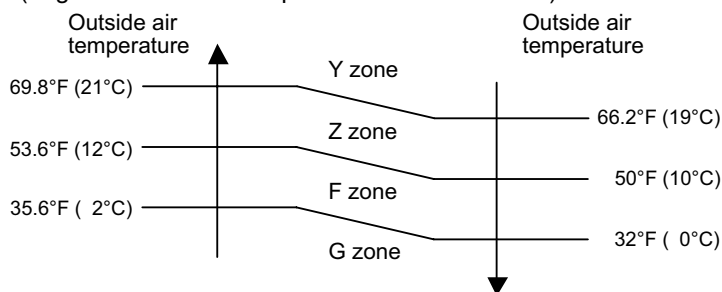

- \* The outdoor fan speed mentioned above depends on the compressor frequency. (When the compressor frequency increases, the outdoor fan speed also changes to the higher speed. When the compressor frequency decreases, the outdoor fan speed also changes to the lower speed.)
- \* After the defrost control is operated on the heating mode, the fan speed keeps at the higher speed as table8 without relating to the compressor frequency.

( Table8 : Outdoor fan speed after the defrost )

ASU9RLF	900rpm
ASU12RLF	950rpm
ASU15RLS	1100rpm

# 7. LOUVER CONTROL

## 1. VERTICAL LOUVER CONTROL

(Function Range)

Each time the button is pressed, the air direction range will change as follow:

① ↔ ② ↔ ③ ↔ ④ ↔ ⑤ ↔ ⑥

Fig.8 : Air Direction Range

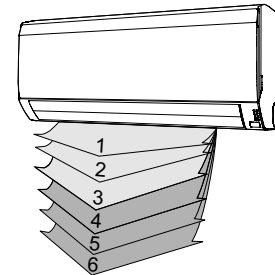

### Types of Air flow Direction Setting:

①, ②, ③, ④, ⑤, ⑥ : During Heating/Cooling/Dry modes

The Remote Controller's display does not change.

- Use the air direction adjustments within the ranges shown above.
- The vertical airflow direction is set automatically as shown, in accordance with the type of operation selected.
  - Cooling / Dry mode : Horizontal flow ①
  - Heating mode : Downward flow ⑥
- During AUTO mode operation, for the first a few minutes after beginning operation, airflow will be horizontal 1; the air direction cannot be adjusted during this period. The air flow direction setting will temporarily become 1 when the temperature of the air flow is low at the start of the Heating mode.

## 2. SWING OPERATION

When the swing signal is received from the remote controller, the vertical louver starts to swing.

(Table9 : Swinging Range)

	Range
Cooling / Dry mode Fan mode (①~③)	① ↔ ④
Heating mode Fan mode (④~⑥)	④ ↔ ⑥

- The SWING operation may stop temporarily when the air conditioner's fan is not operating, or when operating at very low speeds.

## 8. COMPRESSOR CONTROL

### 1. OPEARTION FREQUENCY RANGE

The operation frequency of the compressor is different based on the operation mode as shown in the table10.

(Table10 : Compressor Operation Frequency Range)

	Cooling		Heating		Dry	
	Min	Max	Min	Max	Min	Max
ASU9RLF	22rps	79rps	22rps	99rps	28rps	37rps
ASU12RLF	18rps	96rps	18rps	130rps	25rps	33rps
ASU15RLS	15rps	80rps	15rps	119rps	18rps	29rps

### 2. OPEARTION FREQUENCY CONTROL AT START UP

The compressor frequency soon after the start-up is controlled as shown in the Figure9.

(Fig.9 : Compressor Control at Start-up)

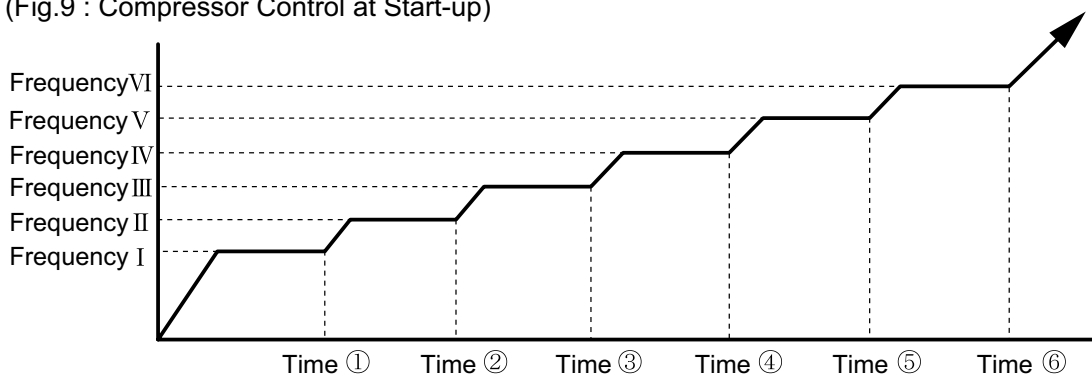

(Frequency)

	Frequency I	Frequency II	Frequency III	Frequency IV	Frequency V	Frequency VI
ASU9RLF	70rps	82rps	92rps	96rps	96rps	96rps
ASU12RLF	56rps	74rps	87rps	97rps	108rps	119rps
ASU15RLS	40rps	57rps	72rps	80rps	101rps	110rps

(Time)

	Time ①	Time ②	Time ③	Time ④	Time ⑤	Time ⑥
ASU9RLF	80sec	140sec	200sec	380sec	440sec	440sec
ASU12RLF	80sec	140sec	200sec	380sec	440sec	500sec
ASU15RLS	80sec	110sec	140sec	200sec	350sec	410sec

## 9. TIMER OPEARTION CONTROL

The table11 shows the available timer setting based on the product model.

(Table11 : Timer Setting)

	ON TIMER / OFF TIMER	PROGRAM TIMER	SLEEP TIMER
ASU9/ 12RLF,15RLS	○	○	○

### 1. OPEARTION FREQUENCY RANGE

- OFF timer : When the clock reaches the set time, the air conditioner will be turned off.

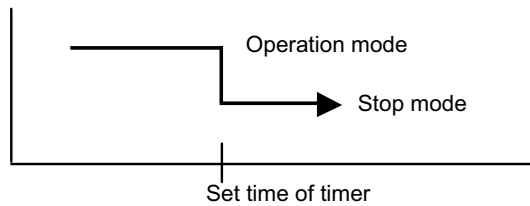

- ON timer : When the clock reaches the set time, the air conditioner will be turned on.

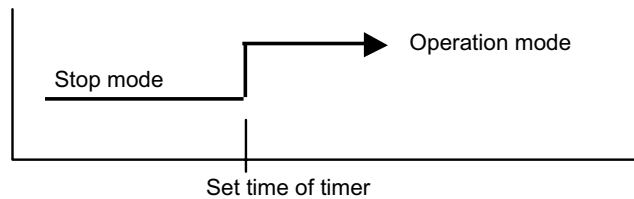

### 2. PROGRAM TIMER

- The program timer allows the OFF timer and ON timer to be used in combination one time.

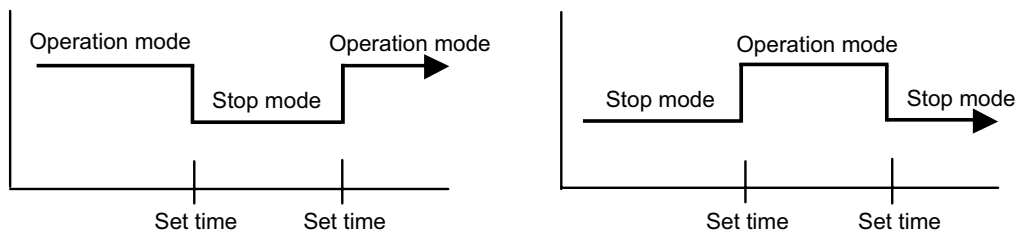

- Operation will start from the timer setting (either OFF timer or ON timer) whichever is closest to the clock's current timer setting.  
The order of operations is indicated by the arrow in the remote control unit's display.
- SLEEP timer operation cannot be combined with ON timer operation.

### 3. SLEEP TIMER

If the sleep is set, the room temperature is monitored and the operation is stopped automatically. If the operation mode or the set temperature is change after the sleep timer is set, the operation is continued according to the changed setting of the sleep timer from that time ON.

#### In the cooling operation mode

When the sleep timer is set, the setting temperature is increased  $2^{\circ}\text{F}(1^{\circ}\text{C})$ . It increases the setting temperature another  $2^{\circ}\text{F}(1^{\circ}\text{C})$  after 1 hour. After that, the setting temperature is not changed and the operation is stopped at the time of timer setting.

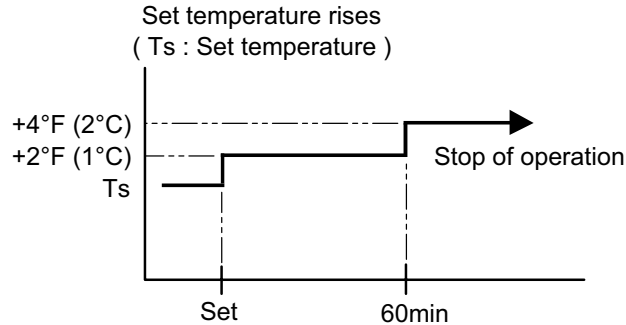

#### In the heating operation mode

When the sleep timer is set, the setting temperature is decreased  $2^{\circ}\text{F}(1^{\circ}\text{C})$ . It decreases the setting temperature another  $2^{\circ}\text{F}(1^{\circ}\text{C})$  every 30 minutes. Upon lowering  $8^{\circ}\text{F}(4^{\circ}\text{C})$  the setting temperature is not changed and the operation stops at the time of timer setting.

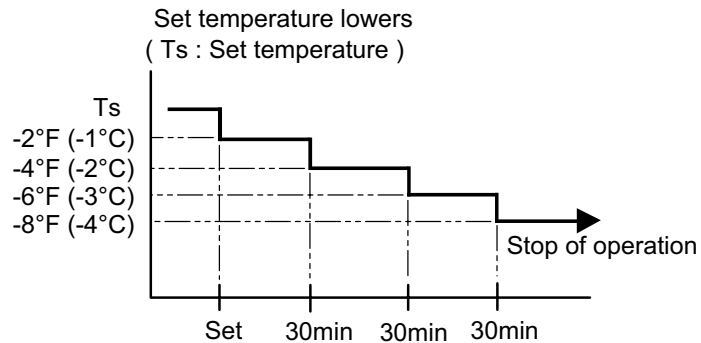

## 10. ELECTRONIC EXPANSION VALVE CONTROL

The most proper opening of the electronic expansion valve is calculated and controlled under the present operating condition based on the Table12.

The compressor frequency, the temperatures detected by the discharge temperature sensor, the indoor heat exchanger sensor, the outdoor heat exchanger sensor, and the outdoor temperature sensor.

Table12 : The pulse range of the electronic expansion valve control

	Operation mode	Pulse range
ASU9/ 12RLF	Cooling / Dry mode	between 60 to 480 pulses.
	Heating mode	between 60 to 480 pulses.
ASU15RLS	Cooling / Dry mode	between 60 to 480 pulses.
	Heating mode	between 45 to 480 pulses.

- \* The expansion valve is set at 480 pulses after 110 seconds of stopping compressor.
- \* At the time of supplying the power to the outdoor unit, the initialization of the electronic expansion valve is operated (528 pulses are input to the closing direction).

## 11. TEST OPERATION CONTROL

Under the condition where the air conditioner runs, press the test run button of the remote control, and the test operation control mode will appear. During test running, the operation lamp and timer lamp of the air conditioner body twinkle simultaneously. Set the test operation mode, and the compressor will continue to run regardless of whether the room temperature sensor detects. The test operation mode is released if 60 minutes have passed after setting up the test operation.

## 12. PREVENT TO RESTART FOR 3 MINUTES ( 3 MINUTES ST )

The compressor won't enter operation status for 2 minutes and 20 seconds after the compressor is stopped, even if any operation is given.

## 13. FOUR-WAY VALVE EXTENSION SELECT

At the time when the air conditioner is switched from the cooling mode to heating mode, the compressor is stopped, and the four-way valve is switched in 2 minutes and 20 seconds later after the compressor stopped.

## 14. AUTO RESTART

When the power was interrupted by a power failure, etc. during operation, the operation contents at that time are memorized and when power is recovered, operation is automatically started with the memorized operation contents.

When the power is interrupted and recovered during timer operation, since the timer operation time is shifted by the time the power was interrupted, an alarm is given by blinking (7 sec ON/2 sec OFF) the indoor unit body timer lamp.

[Operation contents memorized when the power is interrupted]

- Operation mode
- Set temperature
- Set air flow
- Timer mode and timer time
- Set air flow Direction
- Swing
- ECONOMY operation
- MINIMUM HEAT operation

## 15. MANUAL AUTO OPERATION (Indoor unit body operation)

If MANUAL AUTO Button is set, the operation is controlled as shown in Table13.

If the remote control is lost or battery power dissipated, this function will work without the remote control.

(Table13)

	Manual auto operation	Forced cooling operation
OPERATION MODE	Auto changeover	Cooling
FAN CONT. MODE	Auto	Hi
TIMER MODE	Continuous (No timer setting available)	-
SETTING TEMP.	75.2°F (24°C)	Room Temp is not controlled
SETTING LOUVER	Standard	Horizontal
SWING	OFF	OFF
ECONOMY	OFF	-

## 16. FORCED COOLING OPERATION

Forced cooling operation is started when pressing MANUAL AUTO button for 10 seconds or more.

During the forced cooling operation, it operates regardless of room temperature sensor.

Operation LED and timer LED blink during the forced cooling operation. They blink for 1 second ON and 1 second OFF on both operation LED and timer LED (same as test operation).

Forced cooling operation is released after 60 minutes of starting operation.

The FORCED COOLING OPERATION will start as shown in Table13.

## 17. COMPRESSOR PREHEATING

When the outdoor temperature is lower than 68°F(20°C) and the heating operation has been stopped for 30 minutes, power is applied to the compressor and the compressor is heated.

(By heating the compressor, warm air is quickly discharged when operation is started.)

When operation was started and when the outdoor temperature rises to 77°F(25°C) or greater, preheating is ended.

## 18. MINIMUM HEAT OPERATION

The MINIMUM HEAT operation functions by pressing MIN.HEAT button on the remote controller.

The MINIMUM HEAT operation is almost the same operation as below settings.

( Table14 )

Mode	Heating
Setting temperature	50°F (10°C)
Fan mode	AUTO

## 19. ECONOMY OPERATION

The ECONOMY operation functions by pressing ECONOMY button on the remote controller.

The ECONOMY operation is almost the same operation as below settings.

( Table15 )

Mode	Cooling/ Dry	Heating
Target temperature	Setting temp.+2°F (+1°C)	Setting temp.-2°F (-1°C)

## 20. DEFROST OPERATION CONTROL

### 1. CONDITION OF STARTING THE DEFROST OPERATION

The defrost operation starts as shown in the following Table 16.

(Table 16 : Condition of starting Defrost Operation)

Normal defrost	Compressor integrating operation time	
	Less than 25 minutes	More than 25 minutes
	Does not operate	Outdoor heat exchanger temp. $\leq 1.4^{\circ}\text{F}$ ( $-17^{\circ}\text{C}$ ) (at outside air temp. $\geq 14^{\circ}\text{F}$ ( $-10^{\circ}\text{C}$ )) ----- Outdoor heat exchanger temp. $\leq$ Outside air temp. - $12.6^{\circ}\text{F}$ ( $7^{\circ}\text{C}$ ) or Outdoor heat exchanger temp. $\leq -4^{\circ}\text{F}$ ( $-20^{\circ}\text{C}$ ) (at outside air temp. $< 14^{\circ}\text{F}$ ( $-10^{\circ}\text{C}$ ))

Integrating defrost	Compressor integrating operation time	
	More than 240 minutes (For continuous operation)	Less than 10 minutes * ( For intermittent operation )
	Outdoor heat exchanger temp. below $26.6^{\circ}\text{F}$ ( $-3^{\circ}\text{C}$ )	OFF count of the compressor 40 times

\*If the compressor continuous operation time is less than 10 minutes,  
the OFF number of the compressor is counted.  
If any defrost operated, the compressor OFF count is cleared.

### 2. CONDITION OF THE DEFROST OPERATION COMPLETION

Defrost operation is released when the conditions become as shown in Table 17.

(Table 17 : Defrost Release Condition)

Release Condition
Outdoor heat exchanger temperature sensor value is higher than $+60.8^{\circ}\text{F}$ ( $+16^{\circ}\text{C}$ ) or Compressor operation time has passed 15 minutes.



### 3. Defrost Flow Chart

The defrosting shall proceed by the integrating operation time, outdoor temperature and outdoor heat exchanger temperature as follows.

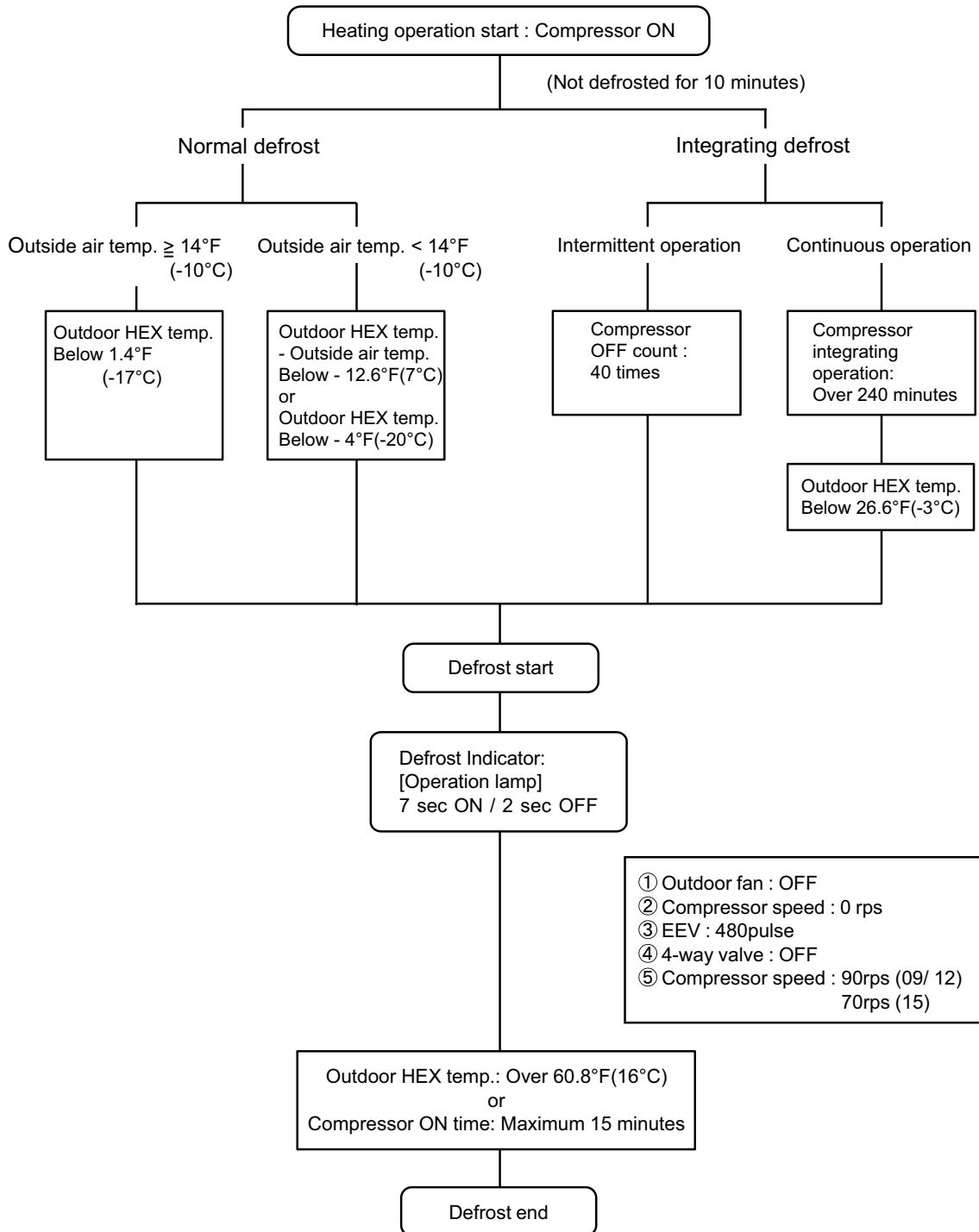

## 21. OFF DEFROST OPEARTION CONTROL

When operation stops in the [Heating operation] mode, if frost is adhered to the outdoor unit heat exchanger, the defrost operation will proceed automatically. In this time, if indoor unit defrost lamp lighting, the outdoor unit will allow the heat exchanger to defrost, and then stop.

### 1. OFF DEFROST OPERATION CONDITION

In heating operation, the outdoor heat exchanger temperature is less than 24.8°F (-4°C), and compressor operation integrating time lasts for more than 30 minutes.

### 2. OFF DEFROST END CONDITION

Release Condition
Outdoor heat exchanger temperature sensor value is higher than 60.8°F (16°C) or Compressor operation time has passed 15 minutes.

### OFF Defrost Flow Chart

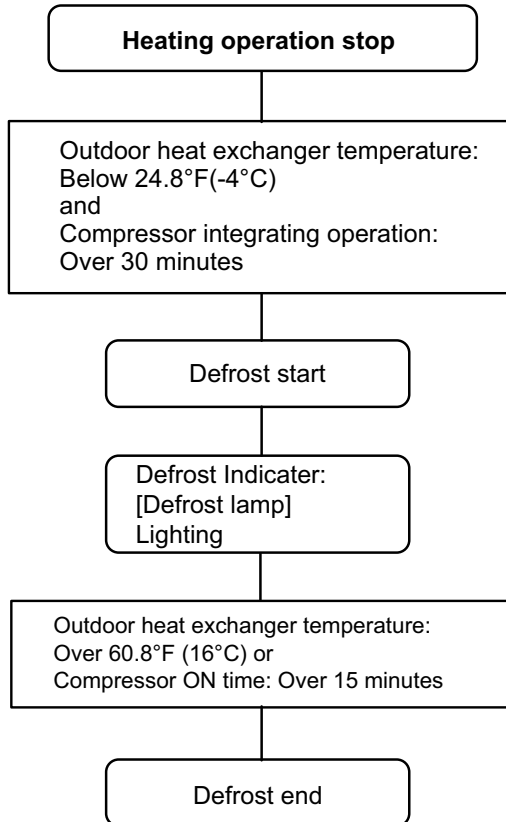

## 22. VARIOUS PROTECTIONS

### 1. DISCHARGE GAS TEMPERATURE OVERRISE PREVENION CONTROL

The discharge gas thermosensor (discharge thermistor : Outdoor side) will detect discharge gas temperature.

When the discharge temperature becomes higher than Temperature I, the compressor frequency is decreased 20rps, and it continues to decrease the frequency for 20rps every 120 seconds until the temperature becomes lower than Temperature II.

When the discharge temperature becomes lower than Temperature II, the control of the control of the compressor frequency is released.

When the discharge temperature becomes higher than Temperature III, the compressor is stopped and the indoor unit LED starts blinking.

(Table18 : Discharge Temperature Over Rise Prevension Control / Release Temperature)

	Temperature I	Temperature II	Temperature III
ASU9/ 12RLF,15RLS	219.2°F (104°C)	213.8°F (101°C)	230°F (110°C)

### 2. CURRENT RELEASE CONTROL

The compressor frequency is controlled so that the outdoor unit input current does not exceeds the current limit velue that was set up with the outdoor temperature.

The compressor frequency returns to the designated frequency of the indoor unit at the time when the frequency becomes lower than the release value.

(Table19 : Current Release Operation Value / Release Value)

#### [ Heating ]

ASU9RLF	
OT (Control / Release)	
	5.5A / 5.0A
62.6°F(17°C)	6.0A / 5.5A
53.6°F(12°C)	7.0A / 6.5A
41°F(5°C)	7.0A / 6.5A

OT : Outdoor Temperature

ASU12RLF	
OT (Control / Release)	
	5.5A / 5.0A
62.6°F(17°C)	7.0A / 6.5A
53.6°F(12°C)	7.5A / 7.0A
41°F(5°C)	8.5A / 8.0A

OT : Outdoor Temperature

ASU15RLS	
OT (Control / Release)	
	7.0A / 6.5A
62.6°F(17°C)	9.0A / 8.5A
53.6°F(12°C)	10.0A / 9.0A
41°F(5°C)	10.0A / 9.5A

OT : Outdoor Temperature

#### [ Cooling ]

ASU9RLF	
OT (Control / Release)	
	3.5A / 3.0A
114.8°F(46°C)	4.0A / 3.5A
104°F(40°C)	5.5A / 5.0A

OT : Outdoor Temperature

ASU12RLF	
OT (Control / Release)	
	4.0A / 3.5A
114.8°F(46°C)	5.0A / 4.5A
104°F(40°C)	6.0A / 5.5A

OT : Outdoor Temperature

ASU15RLS	
OT (Control / Release)	
	4.5A / 3.0A
114.8°F(46°C)	6.0A / 5.5A
104°F(40°C)	8.5A / 8.0A

OT : Outdoor Temperature

### 3. ANTIFREEZING CONTROL (Cooling and Dry mode)

The compressor frequency is decrease on cooling & dry mode when the indoor heat exchanger temperature sensor detects the temperature lower than Temperature I. Then, the anti-freezing control is released when it becomes higher than Temperature II.

(Table19 : Anti-freezing Protection Operation / Release Temperature)

Outdoor temperature	Temperature I	Temperature II
Over than 50°F(10°C) *1 or 53.6°F(12°C) *2	39.2°F (4°C)	44.6°F (7°C)
Less than 50°F(10°C) *1 or 53.6°F(12°C) *2		55.4°F (13°C)

\*1. When the temperature rises.

\*2. When the temperature drops.

### 4. COOLING PRESSURE OVERRISE PROTECTION

When the outdoor unit heat exchange sensor temperature rises to 152.6°F (67°C) or greater, the compressor and the outdoor fan motor are stopped and trouble display is performed.

### 5. HIGH TEMPERATURE RELEASE CONTROL ( HEATING MODE )

On heating mode, the compressor frequency is controlled as following based on the detection value of the indoor heat exchanger temperature sensor.

[ Control System ]

Indoor heat exchange temperature

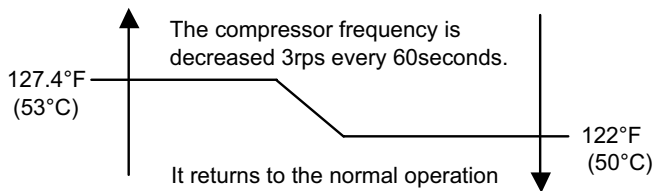

# *WALL MOUNTED type INVERTER*

## **2 . TROUBLE SHOOTING**

## 2. TROUBLESHOOTING

### 2-1 ERROR DISPLAY

#### 2-1-1 WIRED REMOTE CONTROLLER DISPLAY (OPTION)

##### 1. SELF - DIAGNOSIS

When "Er" in Temperature Display is displayed, inspection of the air conditioning system is necessary. Please consult authorized service personnel.

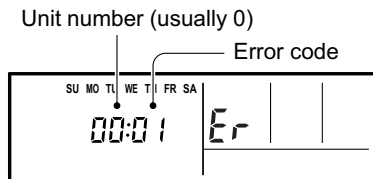



ex. Self-diagnosis check

Error code	Error contents	Trouble shooting
11	Serial communication error	1
12	Remote controller communication error	2
32	Indoor unit main PCB error	3
35	Manual auto switch error	4
41	Room temperature sensor error	5
42	Indoor unit Heat Ex. sensor error	6
51	Indoor unit fan motor error	7
62	Outdoor unit main PCB error	8
64	PFC circuit error	9
65	IPM error	10
71	Discharge thermistor error	11
73	Outdoor unit Heat Ex. sensor error	12
74	Outdoor thermistor error	13
84	Current sensor error	14
94	Trip detection	15
95	Compressor motor control error	16
97	Outdoor unit fan motor error	17
99	4-way valve error	18
A1	Discharge temperature error	19

## 2. ERROR CODE HISTORY DISPLAY

Up to 16 memorized error codes may be displayed for the indoor unit connected to the remote controller.

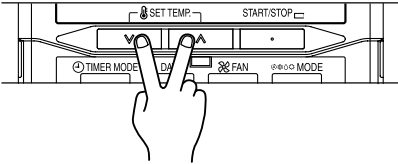
1. Stop the air conditioner operation.

2. Press the SET TEMPERATURE buttons , , [ON/OFF] simultaneously for 3 seconds or more to start the self-diagnosis.

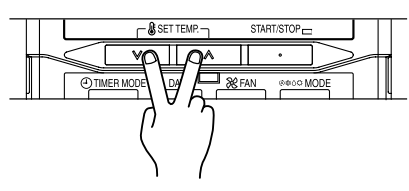

Error code

Error history number

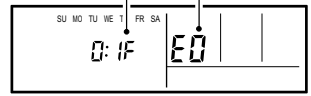

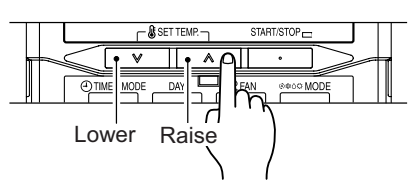

3. Press the SET TEMPERATURE button to select the error history number.



Lower Raise

↩ 0 ↔ 1 ↔ 2 ↔ 3 ↔ 4 ↔ 5 ↔ 6 ↔ 7 ↪

↩ F ↔ E ↔ d ↔ c ↔ b ↔ A ↔ 9 ↔ 8 ↪

4. Press the SET TEMPERATURE buttons ,  simultaneously for 3 seconds or more or there is no key input for 60 seconds to stop the display.

## 2-1-2 OUTDOOR UNIT DISPLAY

### 1. ERROR DISPLAY

1-1. For ASU9/ 12RLF, 15RLS (AOU9/ 12RLF, 15RLS)

Error contents	LED Flashing Pattern	Trouble shooting
Discharge temperature error	Continuously lighting	19
IPM error	0.5sec ON / 0.5sec OFF	10
Current sensor error	2sec ON / 2sec OFF	14
Compressor motor control error	0.1sec ON / 2sec OFF	16
Outdoor unit sensor error (Discharge or Outdoor or Heat EX.)	0.1sec ON / 0.1sec OFF	11,12,13
Outdoor unit fan motor error	5sec ON / 5sec OFF	17

## 2-1-3 INDOOR UNIT DISPLAY

### 1. ERROR DISPLAY

Error contents	Operation lamp (Green)	Timer lamp (Orange)	Economy lamp (Green)	Trouble shooting
Serial communication error	1 times flash	1 times flash	Continuous flash	1
Remote controller communication error	1 times flash	2 times flash		2
Indoor unit main PCB error	3 times flash	2 times flash		3
Manual auto switch error	3 times flash	5 times flash		4
Room temperature sensor error	4 times flash	1 times flash		5
Indoor unit Heat Ex. sensor error	4 times flash	2 times flash		6
Indoor unit fan motor error	5 times flash	1 times flash		7
Outdoor unit main PCB error	6 times flash	2 times flash		8
PFC circuit error	6 times flash	4 times flash		9
IPM error	6 times flash	5 times flash		10
Discharge thermistor error	7 times flash	1 times flash		11
Outdoor unit Heat Ex. sensor error	7 times flash	3 times flash		12
Outdoor thermistor error	7 times flash	4 times flash		13
Current sensor error	8 times flash	4 times flash		14
Trip detection	9 times flash	4 times flash		15
Compressor motor control error	9 times flash	5 times flash		16
Outdoor unit fan motor error	9 times flash	7 times flash		17
4-way valve error	9 times flash	9 times flash		18
Discharge temperature error	10 times flash	1 times flash		19



## 2-2 TROUBLE SHOOTING WITH ERROR CODE

<p><b>Trouble shooting 1-1</b>  <b>OUTDOOR UNIT Error Method:</b>  <b>Serial communication error</b>  <b>(Serial Reverse Transfer Error)</b></p>	<p><b>Indicate or Display:</b>  <b>Outdoor Unit : No indication</b>  <b>Indoor Unit : Operation lamp: 1 time Flash, Timer lamp: 1 time Flash</b>  <b>Economy lamp: Continuous flash.</b>  <b>ERROR CODE : [E : 11]</b></p>
--	--

<p><b>Detective Actuators:</b>          Outdoor unit Main PCB          Outdoor unit Fan motor</p>	<p><b>Detective details:</b>          When the indoor unit cannot receive the serial signal from Outdoor unit more than 2minutes after power ON, or the indoor unit cannot receive the serial signal more than 15seconds during normal operation.</p>
---	---

<p><b>Forecast of Cause:</b>          1. Connection failure    2. External cause    3. Main PCB failure    4. Outdoor unit Fan motor failure</p>
--

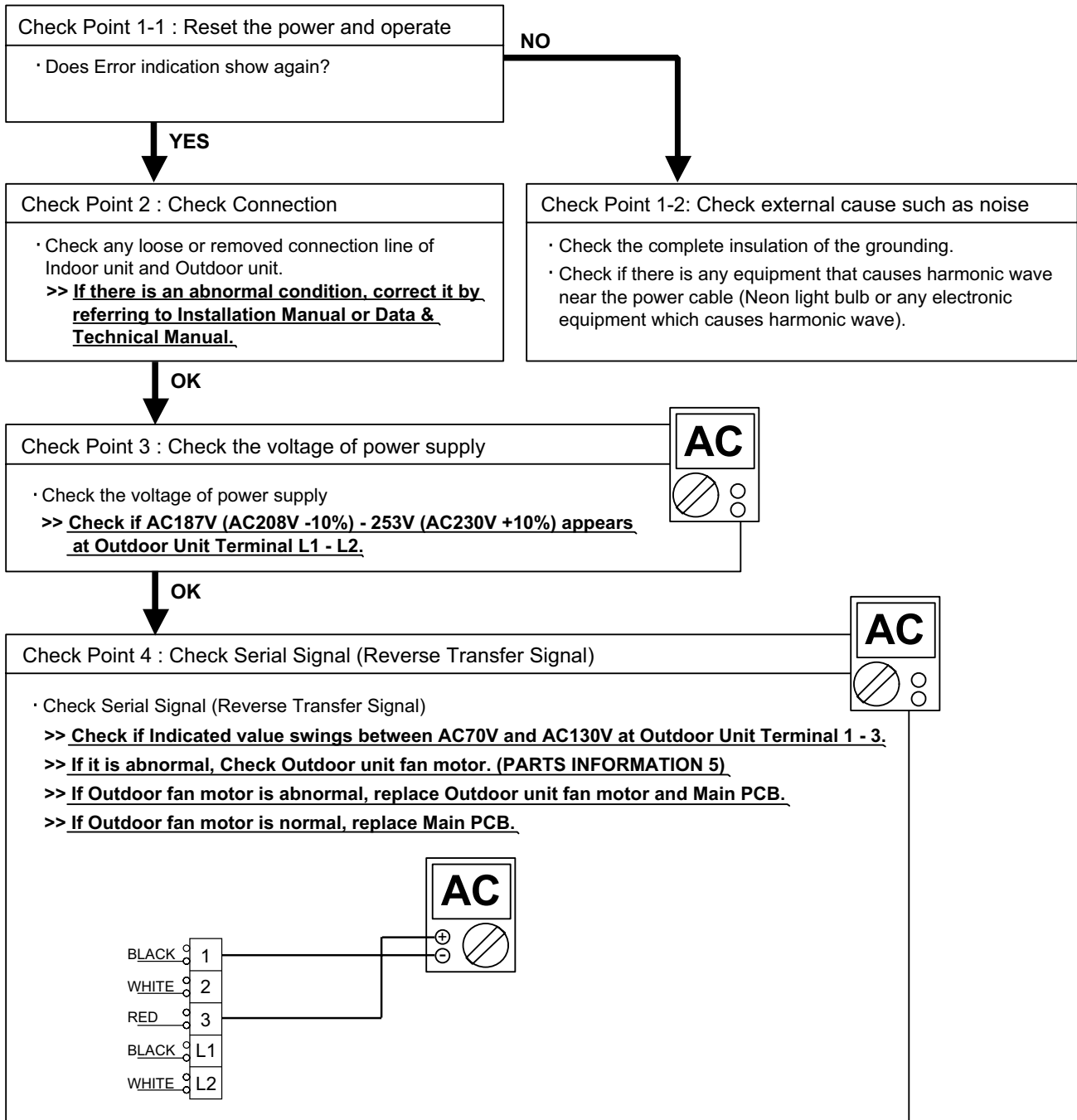

<b>Trouble shooting 1-2</b> <b>INDOOR UNIT Error Method:</b> <b>Serial communication error</b> <b>(Serial Forward Transfer Error)</b>	<b>Indicate or Display:</b> <b>Outdoor Unit : No indication</b> <b>Indoor Unit : Operation lamp: 1 time Flash, Timer lamp: 1 time Flash</b> <b>Economy lamp: Continuous flash.</b> <b>ERROR CODE : [E : 11]</b>
--	---

<b>Detective Actuators:</b> Indoor unit Controller PCB Indoor unit Fan motor	<b>Detective details:</b> When the outdoor unit cannot receive the serial signal from Indoor unit more than 10seconds.
--	---

**Forecast of Cause:**  
 1. Connection failure    2. External cause    3. Controller PCB failure    4. Indoor unit Fan motor failure

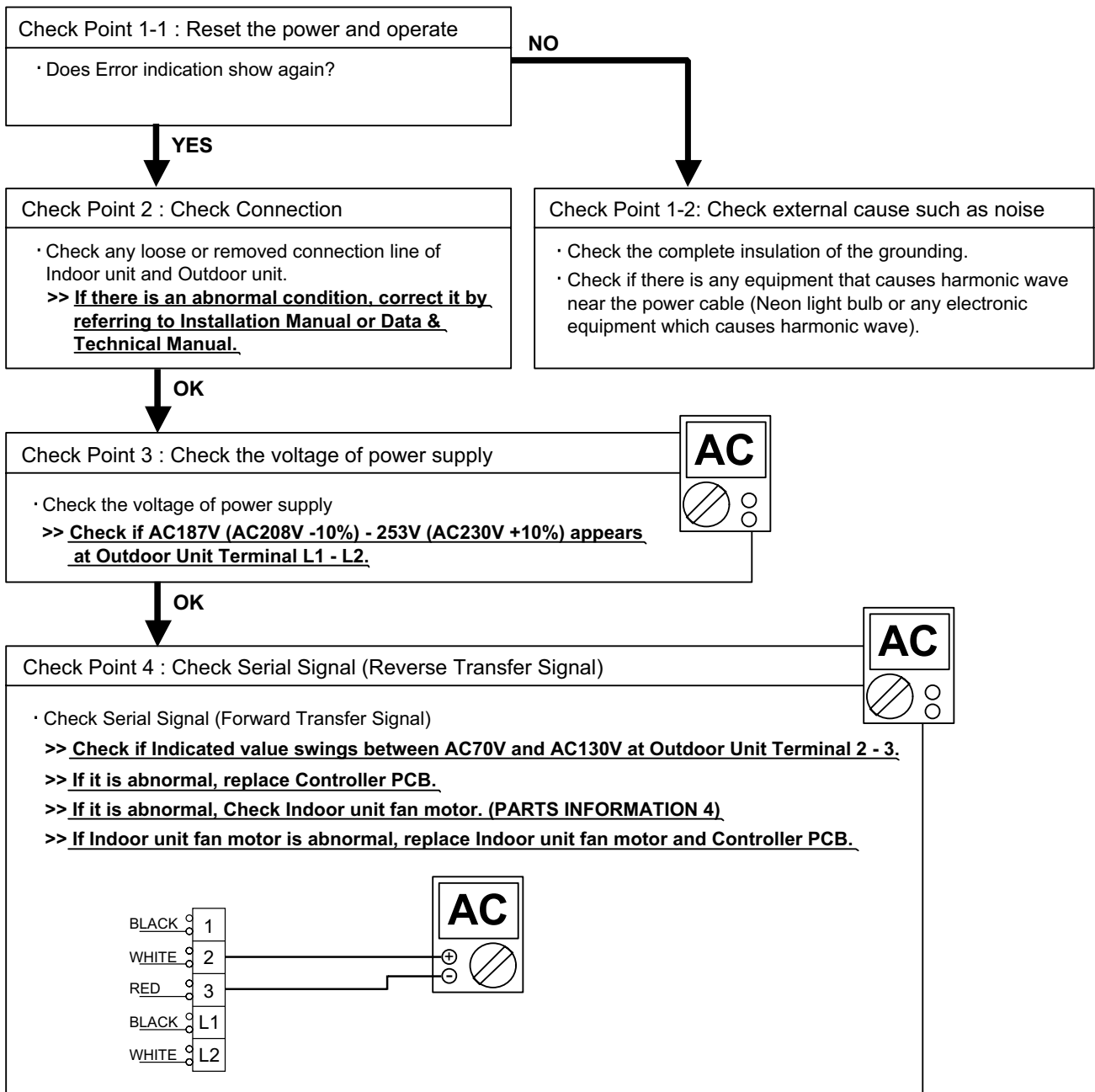

<p><b>Trouble shooting 2</b>  <b>INDOOR UNIT Error Method:</b>  <b>Remote controller communication error</b></p>	<p><b>Indicate or Display:</b>  <b>Outdoor Unit : No indication</b>  <b>Indoor Unit : Operation lamp: 1 time Flash, Timer lamp: 2 times Flash</b>  <b>Economy lamp: Continuous flash.</b>  <b>ERROR CODE : [E : 12]</b></p>
--	---

<p><b>Detective Actuators:</b>  Indoor unit Controller PCB  Wired Remote Control</p>	<p><b>Detective details:</b>  When the indoor unit cannot receive the signal from Wired Remote Control more than 1minute during normal operation.</p>
--	---

Forecast of Cause:  
1. Terminal connection abnormal    2. Wired Remote Control failure    3. Controller PCB failure

Check Point 1 : Check the connection of terminal

After turning off the power, check & correct the followings.

- Check the connection of terminal between remote control and Indoor unit, and check if there is a disconnection of the cable.



Check Point 2 : Check Remote Control and Controller PCB

- Check Voltage at CN305 (terminal 1-3) of UTY-XCBXZ1(Communication kit). (Power supply to Remote Control)

>> If it is DC13V, Remote Control is failure. (Controller PCB is normal)                      >> Replace Remote Control  
>> If it is DC 0V, Controller PCB is failure. (Check Remote Control once again) >> Replace Controller PCB

▶ Upon correcting the removed connector or mis-wiring, reset the power.



<b>Trouble shooting 3</b> <b>INDOOR UNIT Error Method:</b> <b>Indoor unit main PCB error</b>	<b>Indicate or Display:</b> <b>Outdoor Unit : No indication</b> <b>Indoor Unit : Operation lamp: 3 times Flash, Timer lamp: 2 times Flash</b> <b>Economy lamp: Continuous flash.</b> <b>ERROR CODE : [E : 32]</b>
--	---

<b>Detective Actuators:</b> Indoor unit Controller PCB	<b>Detective details:</b> When power is on and there is some below case. 1. When model information of EEPROM is incorrect. 2. When the access to EEPROM failed.
---	--

<b>Forecast of Cause:</b> 1. External cause    2. Defective connection of electric components    3. Controller PCB failure
---

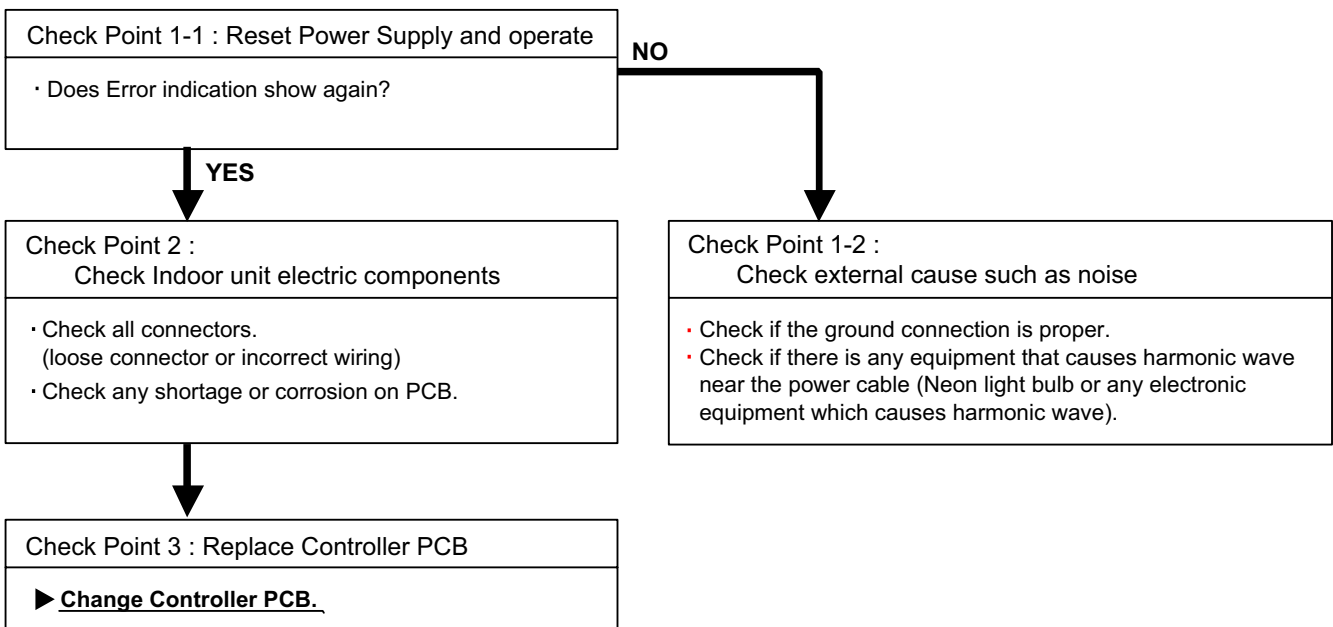

**Note : EEPROM**

EEPROM(Electronically Erasable and Programmable Read Only Memory) is a non-volatile memory which keeps memorized information even if power is turned off. It can change the contents electronically.

To change the contents, it uses higher voltage than normal, and it can not change a partial contents. (Rewriting shall be done upon erasing the all contents.)

There is a limit in a number of rewriting.

<p><b>Trouble shooting 4</b>  <b><u>INDOOR UNIT Error Method:</u></b>  <b>Manual auto switch error</b></p>	<p><b><u>Indicate or Display:</u></b>  <b>Outdoor Unit : No indication</b>  <b>Indoor Unit : Operation lamp: 3 times Flash, Timer lamp: 5 times Flash</b>  <b>Economy lamp: Continuous flash.</b>  <b>ERROR CODE : [E : 35]</b></p>
--	---

<p><b><u>Detective Actuators:</u></b>  Indoor unit Controller PCB  Indicator PCB  Manual auto switch</p>	<p><b><u>Detective details:</u></b>  When the Manual Auto Switch becomes ON for consecutive 60 or more seconds.</p>
--	---

<p><b><u>Forecast of Cause :</u></b>  1. Manual auto switch failure    2.Controller PCB and Indicator PCB failure</p>
---

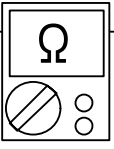
<p>Check Point 1 : Check the Manual auto switch</p> <ul style="list-style-type: none"> <li>· Check if Manual auto switch is kept pressed.</li> <li>· Check ON/OFF switching operation by using a meter.</li> </ul> <p><b>&gt;&gt;If Manual Auto Switch is disabled (on/off switching), replace it.</b></p>	
--	--

↓ OK

<p>Check Point 2 : Replace Controller PCB</p> <p><b>▶ If Check Point 1 do not improve the symptom, change Controller PCB and Indicator PCB.</b></p>
---

<b>Trouble shooting 5</b> <b>INDOOR UNIT Error Method:</b> <b>Room Temperature Sensor Error</b>	<b>Indicate or Display:</b> <b>Outdoor Unit : No indication</b> <b>Indoor Unit : Operation lamp: 4 times Flash, Timer lamp: 1 time Flash</b> <b>Economy lamp: Continuous flash.</b> <b>ERROR CODE : [E : 41]</b>
---	--

<b>Detective Actuators:</b> Indoor unit Controller PCB Room Temperature Thermistor	<b>Detective details:</b> When Room Temperature Thermistor open or short-circuit is detected.
--	--

**Forecast of Cause :**  
 1. Connector connection failure 2. Thermistor failure 3. Controller PCB failure

**Check Point 1 : Check connection of Connector**

- Check if connector is removed.
- Check erroneous connection.
- Check if thermistor cable is open.

**>>Upon correcting the removed connector or mis-wiring, reset the power.**



**Check Point 2 : Remove connector and check Thermistor resistance value**

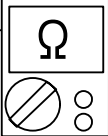

Thermistor Characteristics (Approx. value)

Temperature	-10°C	-5°C	0°C	5°C	10°C	15°C	20°C	25°C
Resistance Value (kΩ)	58.2	44.0	33.6	25.9	20.2	15.8	12.5	10.0

Temperature	30°C	35°C	40°C	45°C
Resistance Value (kΩ)	8.0	6.5	5.3	4.4

► **If Thermistor is either open or shorted, replace it and reset the power.**



**Check Point 3 : Check voltage of Controller PCB (DC5.0V)**



Make sure circuit diagram of indoor unit and check terminal voltage at Thermistor (DC5.0V)

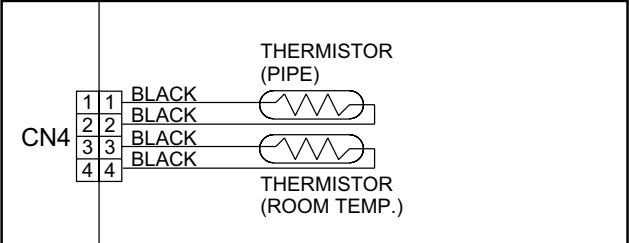

► **If the voltage does not appear, replace Controller PCB.**

<b>Trouble shooting 6</b> <b>INDOOR UNIT Error Method:</b> <b>Indoor unit Heat Ex. sensor error</b>	<b>Indicate or Display:</b> <b>Outdoor Unit : No indication</b> <b>Indoor Unit : Operation lamp: 4 times Flash, Timer lamp: 2 times Flash</b> <b>Economy lamp: Continuous flash.</b> <b>ERROR CODE : [E : 42]</b>
---	---

<b>Detective Actuators:</b> Indoor unit Controller PCB Heat Ex. temperature thermistor	<b>Detective details:</b> When Heat Ex. Temperature Thermistor open or short-circuit is detected.
--	--

Forecast of Cause :  
 1. Connector connection failure 2. Thermistor failure 3. Controller PCB failure

Check Point 1 : Check connection of Connector

- Check if connector is removed.
- Check erroneous connection.
- Check if thermistor cable is open.

**>>Upon correcting the removed connector or mis-wiring, reset the power.**



Check Point 2 : Remove connector and check Thermistor resistance value

Thermistor Characteristics (Approx. value)								
Temperature	-30°C	-20°C	-10°C	-5°C	0°C	5°C	10°C	20°C
Resistance Value (kΩ)	1131.9	579.6	312.3	233.2	176.0	134.2	103.3	62.9

Temperature	30°C	40°C	50°C	60°C	63°C
Resistance Value (kΩ)	39.6	25.6	17.1	11.6	10.4

**► If Thermistor is either open or shorted, replace it and reset the power.**

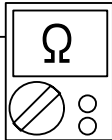

Check Point 3 : Check voltage of Controller PCB (DC5.0V)

Make sure circuit diagram of indoor unit and check terminal voltage at Thermistor (DC5.0V)

CN4	1 1	BLACK	THERMISTOR (PIPE)
	2 2	BLACK	
	3 3	BLACK	THERMISTOR (ROOM TEMP.)
	4 4	BLACK	

**► If the voltage does not appear, replace Controller PCB.**



<b>Trouble shooting 7</b> <b>INDOOR UNIT Error Method:</b> <b>Indoor unit fan motor error</b>	<b>Indicate or Display:</b> <b>Outdoor Unit : No indication</b> <b>Indoor Unit : Operation lamp: 5 times Flash, Timer lamp: 1 time Flash</b> <b>Economy lamp: Continuous flash.</b> <b>ERROR CODE : [E : 51]</b>
---	--

<b>Detective Actuators:</b> Indoor unit Controller PCB Indoor unit fan motor	<b>Detective details:</b> When the condition that actual frequency of Indoor Fan is below 1/3 of target frequency is continued more than 56 seconds.
--	---

<b>Forecast of Cause:</b> 1. Fan rotation failure   2. Fan motor winding open   3. Motor protection by surrounding temperature rise 4. Control PCB failure   5. Indoor unit fan motor failure
---

<b>Check Point 1 : Check rotation of Fan</b> · Rotate the fan by hand when operation is off. (Check if fan is caught, dropped off or locked motor) <b>&gt;&gt;If Fan or Bearing is abnormal, replace it.</b>
---



<b>Check Point 2 : Check ambient temp. around motor</b> · Check excessively high temperature around the motor. (If there is any surrounding equipment that causes heat) <b>&gt;&gt;Upon the temperature coming down, restart operation.</b>
--



<b>Check Point 3 : Check Indoor unit fan motor</b> · Check Indoor unit fan motor. (PARTS INFORMATION 4) <b>&gt;&gt;If Indoor unit fan motor is abnormal, replace Indoor unit fan motor.</b>
---



<b>Check Point 4 : Replace Controller PCB</b> <b>▶ If Check Point 1- 3 do not improve the symptom, replace Controller PCB.</b>
---



<b>Trouble shooting 8</b> <b>OUTDOOR UNIT Error Method:</b> <b>Outdoor unit main PCB error</b>	<b>Indicate or Display:</b> <b>Outdoor Unit : No indication</b> <b>Indoor Unit : Operation lamp: 6 times Flash, Timer lamp: 2 times Flash</b> <b>Economy lamp: Continuous flash.</b> <b>ERROR CODE : [E : 62]</b>
--	---

<b>Detective Actuators:</b> Outdoor unit Main PCB	<b>Detective details:</b> Access to EEPROM failed due to some cause after outdoor unit started.
--	--

<b>Forecast of Cause:</b> 1. External cause (Noise, temporary open, voltage drop) 2. Main PCB failure
--

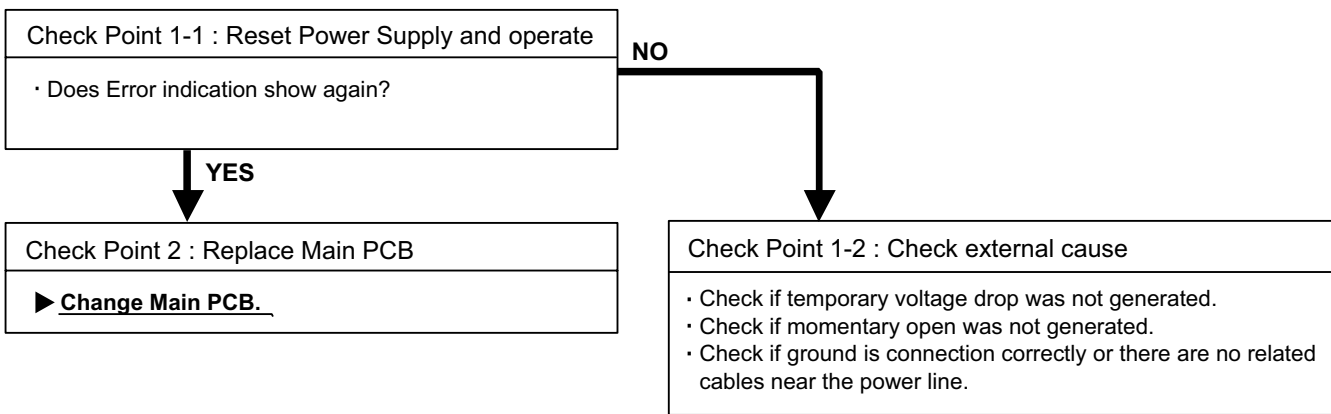

<b>Trouble shooting 9</b> <b><u>OUTDOOR UNIT Error Method:</u></b> <b>PFC circuit error</b>	<b><u>Indicate or Display:</u></b> <b>Outdoor Unit : No indication</b> <b>Indoor Unit : Operation lamp: 6 times Flash, Timer lamp: 4 times Flash</b> <b>Economy lamp: Continuous flash.</b> <b>ERROR CODE : [E : 64]</b>
---	--

<b><u>Detective Actuators:</u></b> Outdoor unit Main PCB	<b><u>Detective details:</u></b> When inverter output DC voltage is higher than 415V for over 3 seconds, the compressor stops. If the same operation is repeated 5 times, the compressor stops permanently.
---	---

<b><u>Forecast of Cause :</u></b> 1. External cause   2. Connector connection failure   3. Main PCB failure
--

<b>Check Point 1 : Check external cause at Indoor and Outdoor (Voltage drop or Noise)</b> <ul style="list-style-type: none"> <li>· Instant drop : Check if there is a large load electric apparatus in the same circuit.</li> <li>· Momentary power failure : Check if there is a defective contact or leak current in the power supply circuit.</li> <li>· Noise : Check if there is any equipment causing harmonic wave near electric line. (Neon bulb or electric equipment that may cause harmonic wave) Check the complete insulation of grounding.</li> </ul>
--

↓ **OK**

<b>Check Point 2 : Check connection of Connector</b> <ul style="list-style-type: none"> <li>· Check if connector is removed.</li> <li>· Check erroneous connection.</li> <li>· Check if cable is open.</li> </ul> <b>&gt;&gt;<u>Upon correcting the removed connector or mis-wiring, reset the power.</u></b>
--

↓ **OK**

<b>Check Point 3 : Replace Main PCB</b> <b>▶ <u>If Check Point 1, 2 do not improve the symptom, change Main PCB.</u></b>
---

<b>Trouble shooting 10</b> <b><u>OUTDOOR UNIT Error Method:</u></b> <b>IPM error</b>	<b><u>Indicate or Display:</u></b> <b>Outdoor Unit : LED 0.5sec ON/ 0.5sec OFF</b> <b>Indoor Unit : Operation lamp: 6 times Flash, Timer lamp: 5 times Flash</b> <b>Economy lamp: Continuous flash.</b> <b>ERROR CODE : [E : 65]</b>
--	--

<b><u>Detective Actuators:</u></b>  Outdoor unit Main PCB Compressor	<b><u>Detective details:</u></b> ① When more than normal operating current to IPM in Main PCB flows, the compressor stops. ② After the compressor restarts, if the same operation is repeated within 40sec, the compressor stops again. ③ If ① and ② repeats 5 times, the compressor stops permanently.
---	--

<b><u>Forecast of Cause :</u></b> 1. Defective connection of electric components    2. Outdoor Fan Operation failure 3. Outdoor Heat Exchanger clogged                    4. Compressor failure                                    5. Main PCB failure
--

<b>Check Point 1 : Check connections of Outdoor Unit Electrical Components</b>
<ul style="list-style-type: none"> <li>· Check if the terminal connection is loose.</li> <li>· Check if connector is removed.</li> <li>· Check erroneous connection.</li> <li>· Check if cable is open.</li> </ul> <b>&gt;&gt; <u>Upon correcting the removed connector or mis-wiring, reset the power.</u></b>

↓  
**OK**

<b>Check Point 2 : Check Outdoor Fan, Heat Exchanger</b>
<ul style="list-style-type: none"> <li>· Is there anything obstructing the air distribution circuit?</li> <li>· Is there any clogging of Outdoor Heat Exchanger?</li> <li>· Is the Fan rotating by hand when operation is off ?</li> </ul> <b>&gt;&gt; <u>If the Fan Motor is locked, replace it.</u></b>

↓  
**OK**

<b>Check Point 3 : Check Outdoor Fan</b>
<ul style="list-style-type: none"> <li>· Check Outdoor Fan Motor. (Refer to Trouble shooting 17)</li> </ul> <b>&gt;&gt; <u>If the Fan Motor is failure, replace it.</u></b>

↓  
**OK**

<b>Check Point 4 : Check Compressor</b>
<ul style="list-style-type: none"> <li>· Check Compressor. (<b>PARTS INFORMATION 2</b>)</li> </ul>

↓  
**OK**

<b>Check Point 5 : Replace Main PCB</b>
<b>▶ <u>If Check Point 1~ 4 do not improve the symptom, change Main PCB.</u></b>

<b>Trouble shooting 11</b> <b>OUTDOOR UNIT Error Method:</b> <b>Discharge thermistor error</b>	<b>Indicate or Display:</b> <b>Outdoor Unit : LED 0.1sec ON/ 0.1sec OFF</b> <b>Indoor Unit : Operation lamp: 7 times Flash, Timer lamp: 1 time Flash</b> <b>Economy lamp: Continuous flash.</b> <b>ERROR CODE : [E : 71]</b>
--	--

<b>Detective Actuators:</b> Outdoor unit Main PCB Discharge pipe temperature thermistor	<b>Detective details:</b> When Discharge pipe temperature thermistor open or short-circuit is detected at power ON or while running the compressor.
---	--

**Forecast of Cause :**  
 1. Connector connection failure 2. Thermistor failure 3. Main PCB failure

**Check Point 1 : Check connection of Connector**

- Check if connector is removed.
- Check erroneous connection.
- Check if thermistor cable is open.

**>>Upon correcting the removed connector or mis-wiring, reset the power.**



**Check Point 2 : Remove connector and check Thermistor resistance value**

**Thermistor Characteristics (Approx. value)**

Temperature	-30°C	-20°C	-10°C	-5°C	0°C	5°C	10°C	20°C	30°C
Resistance Value (kΩ)	1013.1	531.6	292.9	221.1	129.8	134.2	100.9	62.6	40.0

Temperature	40°C	50°C	60°C	70°C	80°C	90°C	100°C	110°C	120°C
Resistance Value (kΩ)	26.3	17.8	12.3	8.7	6.3	4.6	3.4	2.6	2.0

▶ **If Thermistor is either open or shorted, replace it and reset the power.**



**Check Point 3 : Check voltage of Main PCB (DC5.0V)**

Make sure circuit diagram of outdoor unit and check terminal voltage at Thermistor (DC5.0V)

**AOU9RLFW**

**AOU12RLFW, 15RLS**

▶ **If the voltage does not appear, replace Main PCB.**

<b>Trouble shooting 12</b> <b>OUTDOOR UNIT Error Method:</b> <b>Outdoor unit Heat Ex. sensor error</b>	<b>Indicate or Display:</b> <b>Outdoor Unit : LED 0.1sec ON/ 0.1sec OFF</b> <b>Indoor Unit : Operation lamp: 7 times Flash, Timer lamp: 3 times Flash</b> <b>Economy lamp: Continuous flash.</b> <b>ERROR CODE : [E : 73]</b>
--	---

<b>Detective Actuators:</b> Outdoor unit Main PCB Heat exchanger temperature thermistor	<b>Detective details:</b> When Heat exchanger temperature thermistor open or short-circuit is detected at power ON or while running the compressor.
---	--

**Forecast of Cause :**  
 1. Connector connection failure 2. Thermistor failure 3. Main PCB failure

**Check Point 1 : Check connection of Connector**

- Check if connector is removed.
- Check erroneous connection.
- Check if thermistor cable is open.

**>>Upon correcting the removed connector or mis-wiring, reset the power.**



**Check Point 2 : Remove connector and check Thermistor resistance value**

$\Omega$

Thermistor Characteristics (Approx. value)

Temperature	-30°C	-20°C	-10°C	-5°C	0°C	5°C	10°C	20°C	30°C
Resistance Value (k $\Omega$ )	95.6	50.3	27.8	21.0	16.1	12.4	9.6	6.0	3.8

Temperature	40°C	50°C	60°C	70°C	80°C
Resistance Value (k $\Omega$ )	2.5	1.7	1.2	0.8	0.6

**► If Thermistor is either open or shorted, replace it and reset the power.**



**Check Point 3 : Check voltage of Main PCB (DC5.0V)**

**DC**

Make sure circuit diagram of outdoor unit and check terminal voltage at Thermistor (DC5.0V)

**AOU9RLFW**

THERMISTOR (PIPE)	BLACK	1 1	CN61
	BLACK	2 2	
THERMISTOR (DISCHARGE)	BLACK	3 3	
	BLACK	4 4	
THERMISTOR (OUTDOOR)	BLACK	1 1	CN62
	BLACK	2 2	
	BLACK	3 3	

**AOU12RLFW, 15RLS**

THERMISTOR (PIPE)	BLACK	1 1	CN71
	BLACK	2 2	
THERMISTOR (DISCHARGE)	BROWN	3 3	
	BROWN	4 4	
THERMISTOR (OUTDOOR)	BLACK	1 1	CN70
	BLACK	2 2	
	BLACK	3 3	

**► If the voltage does not appear, replace Main PCB.**

02-16

<b>Trouble shooting 13</b> <b>OUTDOOR UNIT Error Method:</b> <b>Outdoor thermistor error</b>	<b>Indicate or Display:</b> <b>Outdoor Unit : LED 0.1sec ON/ 0.1sec OFF</b> <b>Indoor Unit : Operation lamp: 7 times Flash, Timer lamp: 4 times Flash</b> <b>Economy lamp: Continuous flash.</b> <b>ERROR CODE : [E : 74]</b>
--	---

<b>Detective Actuators:</b> Outdoor unit Main PCB Outdoor temperature thermistor	<b>Detective details:</b> When Outdoor temperature thermistor open or short-circuit is detected at power ON or while running the compressor.
--	---

**Forecast of Cause :**  
 1. Connector connection failure 2. Thermistor failure 3. Main PCB failure

**Check Point 1 : Check connection of Connector**

- Check if connector is removed.
- Check erroneous connection.
- Check if thermistor cable is open.

**>>Upon correcting the removed connector or mis-wiring, reset the power.**



**Check Point 2 : Remove connector and check Thermistor resistance value**

$\Omega$

Thermistor Characteristics (Approx. value)

Temperature	-30°C	-25°C	-20°C	-15°C	-10°C	-5°C	0°C	5°C	10°C
Resistance Value (k $\Omega$ )	224.3	159.7	115.2	84.2	62.3	46.6	35.2	26.9	20.7

Temperature	15°C	20°C	25°C	30°C	35°C	40°C	45°C	50°C	55°C
Resistance Value (k $\Omega$ )	16.1	12.6	10.0	8.0	6.4	5.2	4.2	3.5	2.8

**► If Thermistor is either open or shorted, replace it and reset the power.**



**Check Point 3 : Check voltage of Main PCB (DC5.0V)**

**DC**

Make sure circuit diagram of outdoor unit and check terminal voltage at Thermistor (DC5.0V)

**AOU9RLF**

**AOU12RLF, 15RLS**

**► If the voltage does not appear, replace Main PCB.**

<b>Trouble shooting 14</b> <b><u>OUTDOOR UNIT Error Method:</u></b> <b>Current sensor error</b>	<b><u>Indicate or Display:</u></b> <b>Outdoor Unit : LED 2sec ON/ 2sec OFF</b> <b>Indoor Unit : Operation lamp: 8 times Flash, Timer lamp: 4 times Flash</b> <b>Economy lamp: Continuous flash.</b> <b>ERROR CODE : [E : 84]</b>
---	--

<b><u>Detective Actuators:</u></b> Outdoor unit Main PCB	<b><u>Detective details:</u></b> When Input Current Sensor has detected 0A, while Inverter Compressor is operating at higher than 56rps, after 1minute upon starting the Compressor. (Except during the defrost operation)
---	---

<b><u>Forecast of Cause :</u></b> 1. Defective connection of electric components    2. External cause    3. Main PCB failure
---

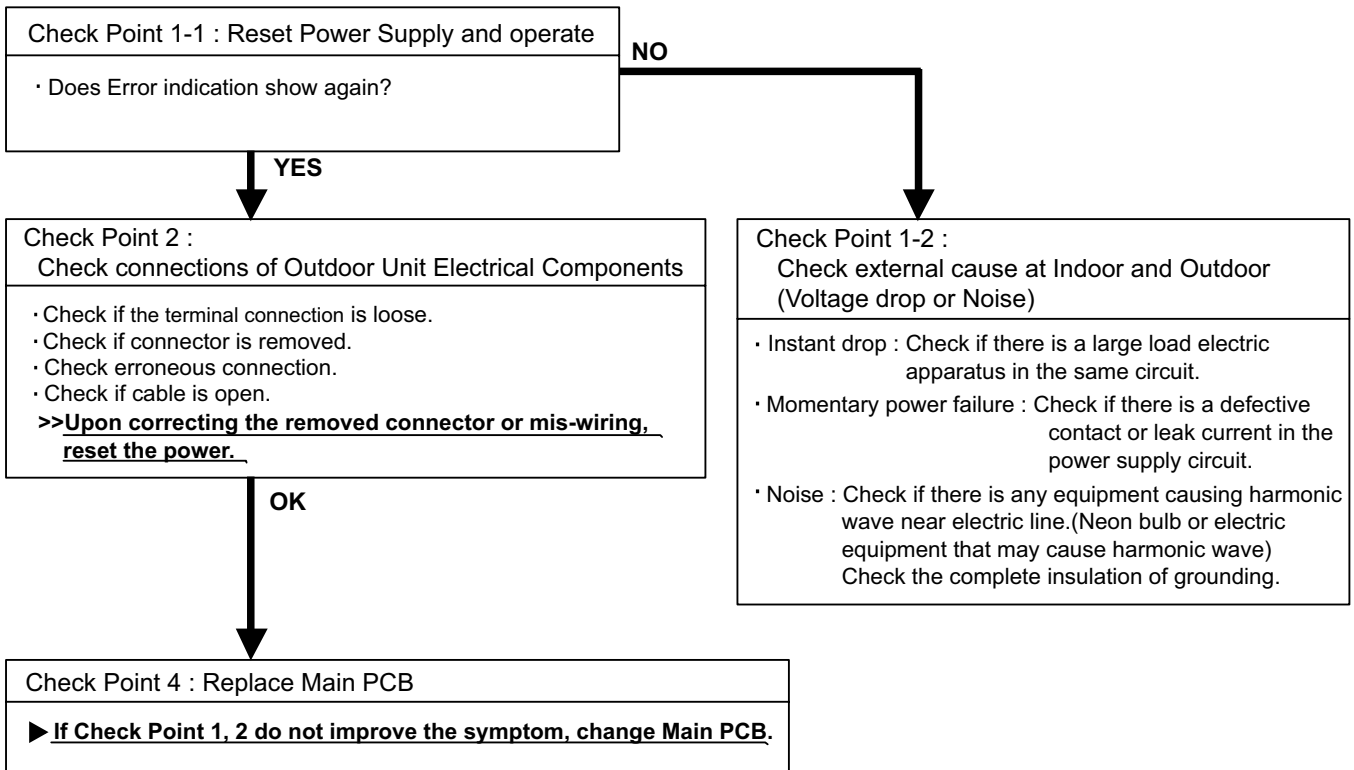

<b>Trouble shooting 15</b> <b><u>OUTDOOR UNIT Error Method:</u></b> <b>Trip detection</b>	<b><u>Indicate or Display:</u></b> <b>Outdoor Unit : LED 0.1sec ON/ 2sec OFF</b> <b>Indoor Unit : Operation lamp: 9 times Flash, Timer lamp: 4 times Flash</b> <b>Economy lamp: Continuous flash.</b> <b>ERROR CODE : [E : 94]</b>
---	--

<b><u>Detective Actuators:</u></b> Outdoor unit Main PCB Compressor	<b><u>Detective details:</u></b> • "Protection stop by overcurrent generation after inverter compressor start processing completed" generated consecutively 10 times. * The number of generations is reset if the start-up of the compressor succeeds.
---	--

<b><u>Forecast of Cause :</u></b> <ol style="list-style-type: none"> <li>1. Outdoor unit fan operation defective, foreign matter on hear exchanger, excessive rise of ambient temperature</li> <li>2. Inverter PCB failure</li> <li>3. Inverter compressor failure (lock, winding short)</li> </ol>
---

<b>Check Point 1 : Check the outdoor unit fan operation, heat exchanger, ambient temperature</b>
<ul style="list-style-type: none"> <li>· No obstructions in air passages?</li> <li>· Heat exchange fins clogged</li> <li>· Outdoor unit fan motor check</li> <li>· Ambient temperature not raised by the effect of other heat sources?</li> <li>· Discharged air not sucked in?</li> </ul>

↓  
**OK**

<b>Check Point 2: Replace Main PCB</b>
<b>▶ <u>If Check Point 1 do not improve the symptom, change Main PCB.</u></b>

↓  
**OK**

<b>Check Point 3: Replace Compressor</b>
<b>▶ <u>If Check Point 2 do not improve the symptom, change Compressor.</u></b>



<b>Trouble shooting 16</b> <b><u>OUTDOOR UNIT Error Method:</u></b> <b>Compressor motor control error</b>	<b><u>Indicate or Display:</u></b> <b>Outdoor Unit : LED 0.1sec ON/ 2sec OFF</b> <b>Indoor Unit : Operation lamp: 9 times Flash, Timer lamp: 5 times Flash</b> <b>Economy lamp: Continuous flash.</b> <b>ERROR CODE : [E : 95]</b>
---	--

<b><u>Detective Actuators:</u></b>  Outdoor unit Main PCB Compressor	<b><u>Detective details:</u></b>  ① While running the compressor, if the detected rotor location is out of phase with actual rotor location more than 90°, the compressor stops. ② After the compressor restarts, if the same operation is repeated within 40sec, the compressor stops again. ③ If ① and ② repeats 5 times, the compressor stops permanently.
---	---

<b><u>Forecast of Cause :</u></b> 1. Defective connection of electric components    2. Main PCB failure    3. Compressor failure
---

Check Point 1 : Check Noise from Compressor

---

· Turn on Power and check operation noise.

▶ **If an abnormal noise show, replace Compressor.**



Check Point 2 : Check connection of around the Compressor components

---

For Compressor Terminal, Main PCB

- Check if connector is removed.
- Check erroneous connection.
- Check if cable is open.

(Refer to PARTS INFORMATION 2)

>>**Upon correcting the removed connector or mis-wiring, reset the power.**



Check Point 3: Replace Main PCB

---

▶ **If Check Point 1,2 do not improve the symptom, change Main PCB.**



Check Point 4: Replace Compressor

---

▶ **If Check Point 3 do not improve the symptom, change Compressor.**

<b>Trouble shooting 17</b> <b><u>OUTDOOR UNIT Error Method:</u></b> <b>Outdoor unit fan motor error</b>	<b><u>Indicate or Display:</u></b> <b>Outdoor Unit : LED 5sec ON/ 5sec OFF</b> <b>Indoor Unit : Operation lamp: 9 times Flash, Timer lamp: 7 times Flash</b> <b>Economy lamp: Continuous flash.</b> <b>ERROR CODE : [E : 97]</b>
---	--

<b><u>Detective Actuators:</u></b> Outdoor unit Main PCB Outdoor unit fan motor	<b><u>Detective details:</u></b> ① When outdoor fan rotation speed is less than 100rpm in 20 seconds after fan motor starts, fan motor stops. ② After fan motor restarts, if the same operation within 60sec is repeated 3 times in a row, compressor and fan motor stops. ③ If ① and ② repeats 5 times in a row, compressor and fan motor stops permanently.
---	--

<b><u>Forecast of Cause:</u></b> 1. Fan rotation failure   2. Motor protection by surrounding temperature rise   3. Main PCB failure 4. Outdoor unit fan motor failure
--

<b>Check Point 1 : Check rotation of Fan</b>
· Rotate the fan by hand when operation is off. (Check if fan is caught, dropped off or locked motor) <b>&gt;&gt;If Fan or Bearing is abnormal, replace it.</b>

↓ **OK**

<b>Check Point 2 : Check ambient temp. around motor</b>
· Check excessively high temperature around the motor. (If there is any surrounding equipment that causes heat) <b>&gt;&gt;Upon the temperature coming down, restart operation.</b>

↓ **OK**

<b>Check Point 3 : Check Outdoor unit fan motor</b>
· Check Outdoor unit fan motor. <b>(PARTS INFORMATION 5)</b> <b>&gt;&gt;If Outdoor unit fan motor is abnormal, replace Outdoor unit fan motor.</b>

↓ **OK**

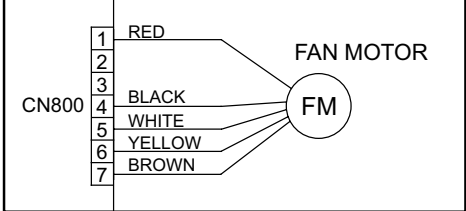
<b>Check Point 4 : Check Output Voltage of Main PCB</b>	<div style="border: 1px solid black; padding: 5px; width: fit-content; margin: 0 auto;"> <b>DC</b>   </div>								
· Check outdoor unit circuit diagram and the voltage. (Measure at Main PCB side connector)									
	<table border="1" style="margin: auto;"> <thead> <tr> <th>Read wire</th> <th>DC voltage</th> </tr> </thead> <tbody> <tr> <td>Red - Black</td> <td>280V ±10% (09/12RLFW)</td> </tr> <tr> <td></td> <td>240 - 400V (15RLS)</td> </tr> <tr> <td>White - Black</td> <td>15 ±1.5V</td> </tr> </tbody> </table>	Read wire	DC voltage	Red - Black	280V ±10% (09/12RLFW)		240 - 400V (15RLS)	White - Black	15 ±1.5V
Read wire	DC voltage								
Red - Black	280V ±10% (09/12RLFW)								
	240 - 400V (15RLS)								
White - Black	15 ±1.5V								
<b>▶ If the voltage is not correct, replace Main PCB.</b>									

<b>Trouble shooting 18</b> <b><u>INDOOR UNIT Error Method:</u></b> <b>4-way valve error</b>	<b><u>Indicate or Display:</u></b> <b>Outdoor Unit : No indication</b> <b>Indoor Unit : Operation lamp: 9 times Flash, Timer lamp: 9 times Flash</b> <b>Economy lamp: Continuous flash.</b> <b>ERROR CODE : [E : 99]</b>
---	--

<b><u>Detective Actuators:</u></b> Indoor unit Controller PCB Heat Ex. temperature thermistor Room temperature thermistor 4-way valve	<b><u>Detective details:</u></b> When the indoor heat exchanger temperature is compared with the room temperature, and either following condition is detected continuously two times, the compressor stops. <ul style="list-style-type: none"> <li>• Cooling or Dry operation            [Indoor heat exchanger temp.] - [Room temp.] &gt; 18degF (10degC)</li> <li>• Heating operation            [Indoor heat exchanger temp.] - [room temp.] &lt; -18degF (-10degC)</li> </ul> If the same operation is repeated 5 times, the compressor stops permanently.
---	---

<b><u>Forecast of Cause :</u></b> 1. Connector connection failure   2. Thermistor failure   3. Coil failure   4. 4-way valve failure 5. Controller PCB failure
--

<b>Check Point 1 : Check connection of Connector</b> <ul style="list-style-type: none"> <li>• Check if connector is removed.</li> <li>• Check erroneous connection.</li> <li>• Check if thermistor cable is open.</li> </ul> <b>&gt;&gt; <u>Upon correcting the removed connector or mis-wiring, reset the power.</u></b>
--



<b>Check Point 2 : Check each thermistor</b> <ul style="list-style-type: none"> <li>• Isn't it fallen off the holder?</li> <li>• Is there a cable pinched?</li> </ul> <b>&gt;&gt; <u>Check characteristics of thermistor (Refer to Trouble shooting 5, 6), If defective, replace the thermistor</u></b>
--



<b>Check Point 3 : Check the solenoid coil and 4-way valve</b> [ Solenoid coil ] <ul style="list-style-type: none"> <li>• Remove CN501(09RL), CN30(12/ 15RL) from PCB and check the resistance value of coil. Resistance value is 1.22kΩ ~ 1.49kΩ (at 20°C).</li> </ul> <b>&gt;&gt; <u>If it is Open or abnormal resistance value, replace Solenoid Coil.</u></b> [ 4-way valve ] <ul style="list-style-type: none"> <li>• Check each piping temperature, and the location of the valve by the temperature difference.</li> </ul> <b>&gt;&gt; <u>If the value location is not proper, replace 4-way valve.</u></b>
--



<b>Check Point 4 : Replace Controller PCB</b> <b>▶ <u>If Check Point 1- 3 do not improve the symptom, replace Controller PCB.</u></b>
--

<b>Trouble shooting 19</b> <b><u>OUTDOOR UNIT Error Method:</u></b> <b>Discharge temperature error</b>	<b><u>Indicate or Display:</u></b> <b>Outdoor Unit : Continuously lighting</b> <b>Indoor Unit : Operation lamp: 10 times Flash, Timer lamp: 1 time Flash</b> <b>Economy lamp: Continuous flash.</b> <b>ERROR CODE : [E : A1]</b>
--	--

<b><u>Detective Actuators:</u></b> Outdoor unit Main PCB Discharge pipe temperature thermistor	<b><u>Detective details:</u></b> ① When the discharge temperature becomes higher than 230°F (110°C), the compressor stops. ② After the compressor restarts, if the same operation is repeated, the compressor stops permanently.
--	--

**Forecast of Cause :**  
 1. Valve is close 2. EEV failure 3. Gas Leak, less 4. Discharge Thermistor failure  
 5. Outdoor Fan Operation failure 6. Outdoor Heat Exchanger clogged

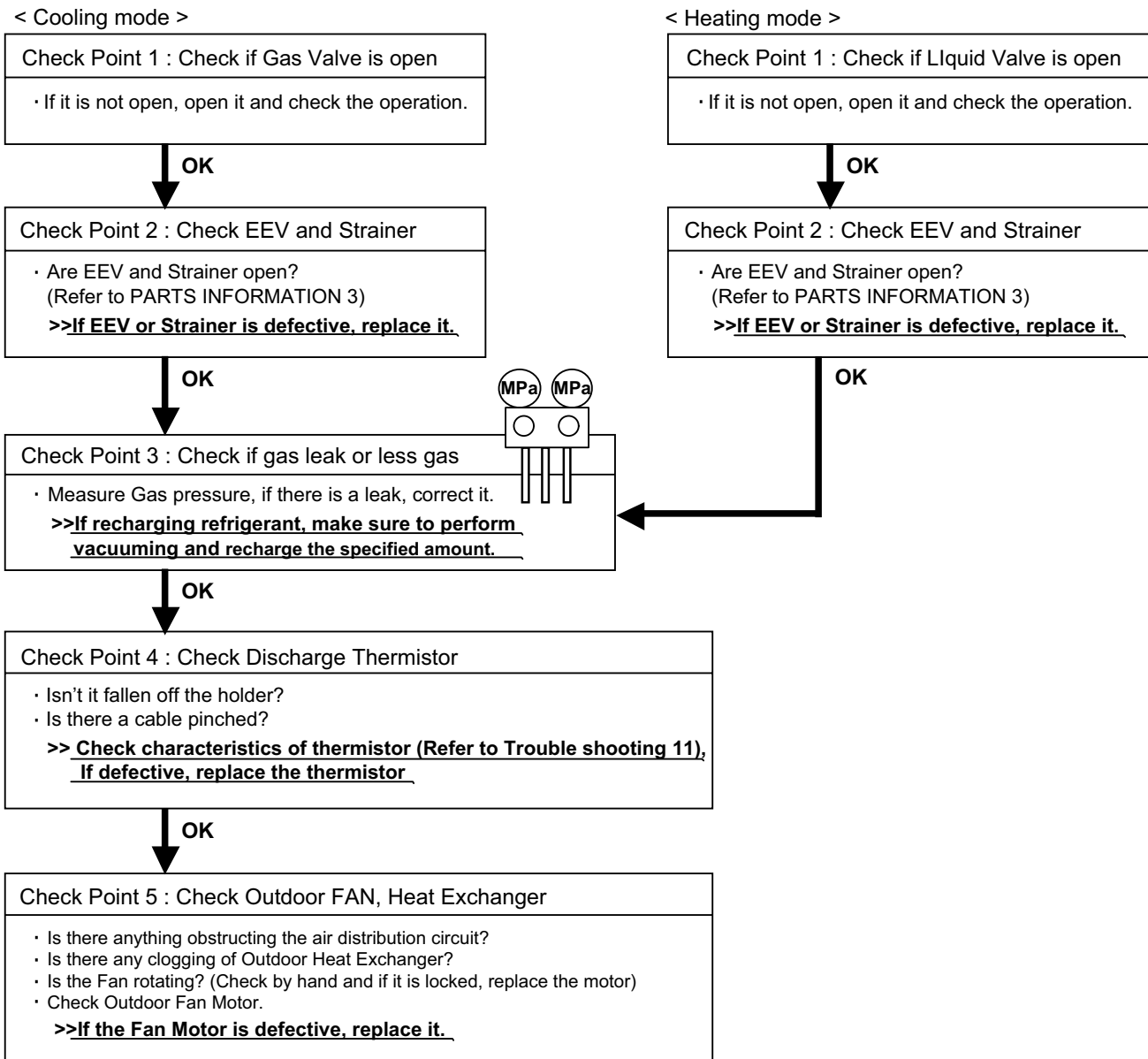

## 2-3 TROUBLE SHOOTING WITH NO ERROR CODE

### Trouble shooting 20

Indoor Unit - No Power

#### Forecast of Cause:

1. Power Supply failure
2. External cause
3. Electrical Components defective

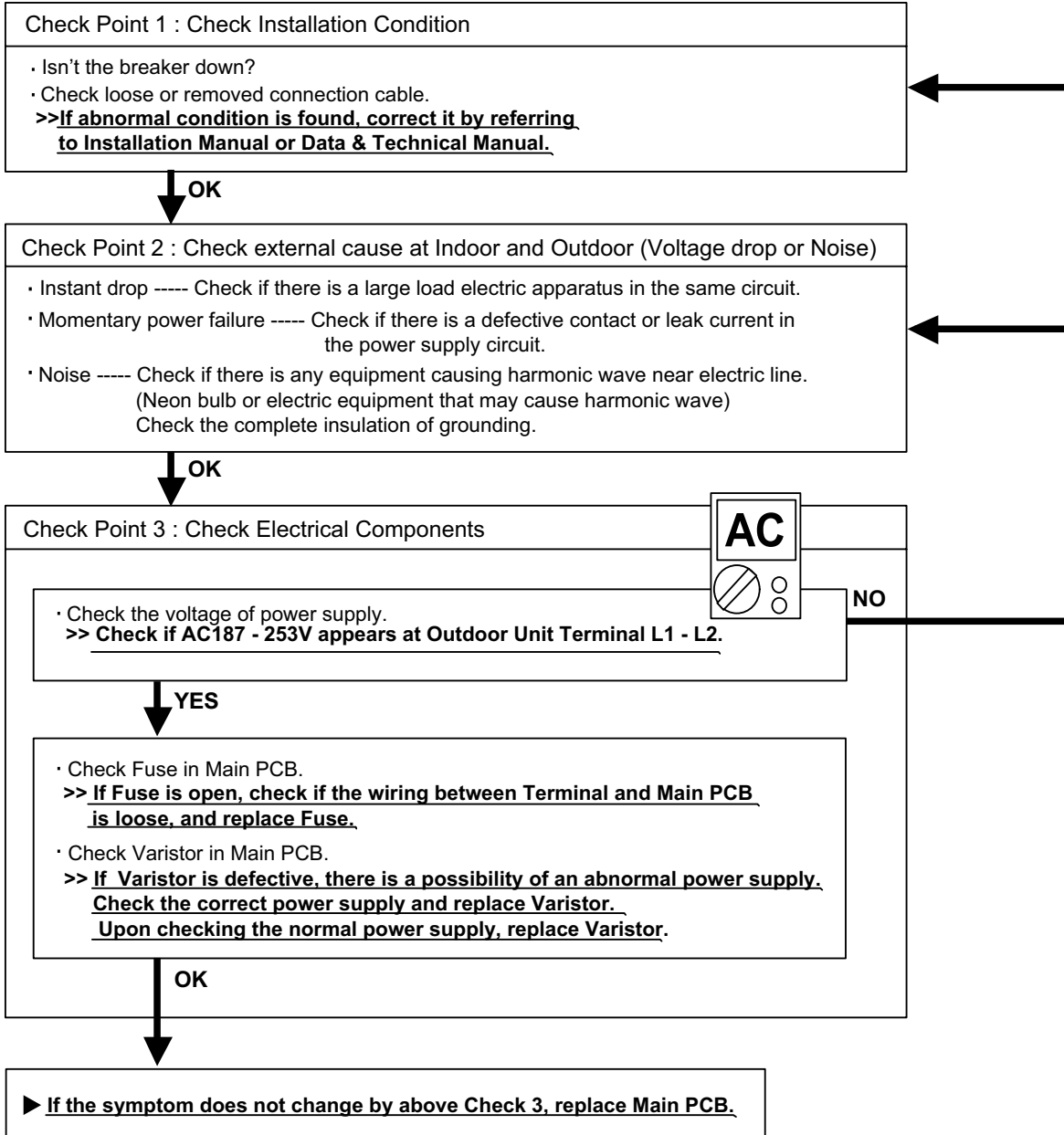

## Trouble shooting 21

Outdoor Unit - No Power

### Forecast of Cause:

1. Power Supply failure
2. External cause
3. Electrical Components defective

#### Check Point 1 : Check Installation Condition

- Isn't the breaker down?
- Check loose or removed connection cable.
- >>If abnormal condition is found, correct it by referring to Installation Manual or Data & Technical Manual.**

OK

#### Check Point 2 : Check external cause at Indoor and Outdoor (Voltage drop or Noise)

- Instant drop ----- Check if there is a large load electric apparatus in the same circuit.
- Momentary power failure ----- Check if there is a defective contact or leak current in the power supply circuit.
- Noise ----- Check if there is any equipment causing harmonic wave near electric line.  
(Neon bulb or electric equipment that may cause harmonic wave)  
Check the complete insulation of grounding.

OK

#### Check Point 3 : Check Electrical Components

- Check the voltage of power supply.
- >> Check if AC187 - 253V appears at Outdoor Unit Terminal L1 - L2.**

YES

- Check Fuse in Main PCB.
- >> If Fuse is open, check if the wiring between Terminal and Main PCB is loose, and replace Fuse.**
- Check Varistor in Main PCB.
- >> If Varistor is defective, there is a possibility of an abnormal power supply. Check the correct power supply and replace Varistor. Upon checking the normal power supply, replace Varistor.**

OK

► **If the symptom does not change by above Check 3, replace Main PCB.**

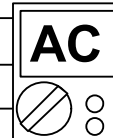

NO

## Trouble shooting 22

No Operation (Power is ON)

### Forecast of Cause:

1. Setting/ Connection failure
2. External cause
3. Electrical Component defective

### Check Point 1 : Check indoor and outdoor installation condition

- Indoor Unit - Check incorrect wiring between Indoor Unit - Remote Control.  
Or, check if there is an open cable connection.
  - Are these Indoor Unit, Outdoor Unit, and Remote Control suitable model numbers to connect?
- >> If there is some abnormal condition, correct it by referring to Installation manual and Data & Technical Manual.**

OK

Turn off Power and check/ correct followings.

- Is there loose or removed communication line of Indoor Unit and Outdoor Unit?

OK

### Check Point 2 : Check external cause at Indoor and Outdoor (Voltage drop or Noise)

- Instant drop ----- Check if there is a large load electric apparatus in the same circuit.
- Momentary power failure ----- Check if there is a defective contact or leak current in the power supply circuit.
- Noise ----- Check if there is any equipment causing harmonic wave near electric line.  
(Neon bulb or electric equipment that may cause harmonic wave)  
Check the complete insulation of grounding.

OK

### Check Point 3 : Check Electrical Components at Indoor and Outdoor

- Check Voltage at CN305 (terminal 1-3) of UTY-XCBXZ1(Communication kit).  
(Power supply to Remote Control)

**>> If it is DC13V, Remote Control is failure. (Controller PCB is normal) >> Replace Remote Control**  
**>> If it is DC 0V, Controller PCB is failure. (Check Remote Control once again) >> Replace Controller PCB**  
**>> If the symptom does not change by above Check 1, 2, 3, replace Main PCB of Outdoor unit.**



### Trouble shooting 23

No Cooling / No Heating

#### Forecast of Cause:

1. Indoor Unit error
2. Outdoor Unit error
3. Effect by Surrounding environment
4. Connection Pipe / Connection Wire failure
5. Refrigeration cycle failure

#### Check Point 1 : Check Indoor Unit

- Does Indoor Unit FAN run on HIGH FAN?
- Is Air Filter dirty?
- Is Heat Exchanger clogged?
- Check if Energy save function is operated.



#### Check Point 2 : Check Outdoor Unit Operation

- Check if Outdoor Unit is operating
- Check any objects that obstruct the air flow route.
- Check clogged Heat Exchanger.
- Is the Valve open?



#### Check Point 3 : Check Site Condition

- Is capacity of Indoor Unit fitted to Room size?
- Any windows open? Or direct sunlight ?



#### Check Point 4 : Check Indoor/ Outdoor Installation Condition

- Check connection pipe (specified pipe length & Pipe diameter?)
- Check any loose or removed communication line.
- >> **If there is an abnormal condition, correct it by referring to Installation Manual or Data & Technical Manual.**



#### Check Point 5 : Check Refrigeration Cycle

- Check if Strainer is clogged (Refer to the figure at right).
- Measure Gas Pressure and if there is a leakage, correct it.
- >> **When recharging the refrigerant, make sure to perform vacuuming, and recharge the specified amount.**
- Check EEV (PARTS INFORMATION 3)
- Check Compressor (PARTS INFORMATION 1,2)

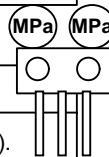

#### Attention

Strainer normally does not have temperature difference between inlet and outlet as shown in ①, but if there is a difference like shown in ②, there is a possibility of inside clogged. In this case, replace Strainer.

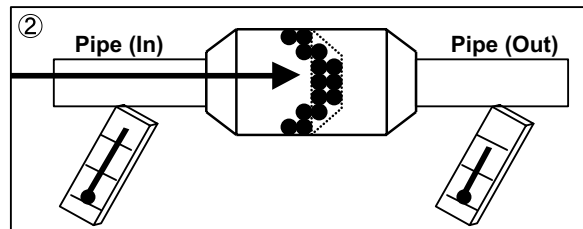
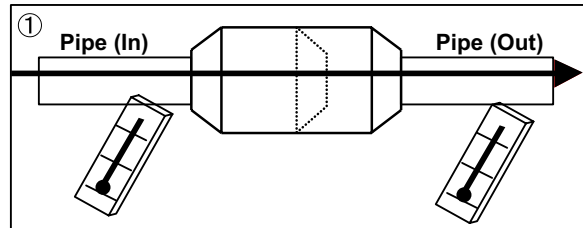



**Trouble shooting 24**  
Abnormal Noise

Forecast of Cause :  
1. Abnormal installation (Indoor/ Outdoor)  
2. Fan failure (Indoor/ Outdoor)  
3. Compressor failure (Outdoor)

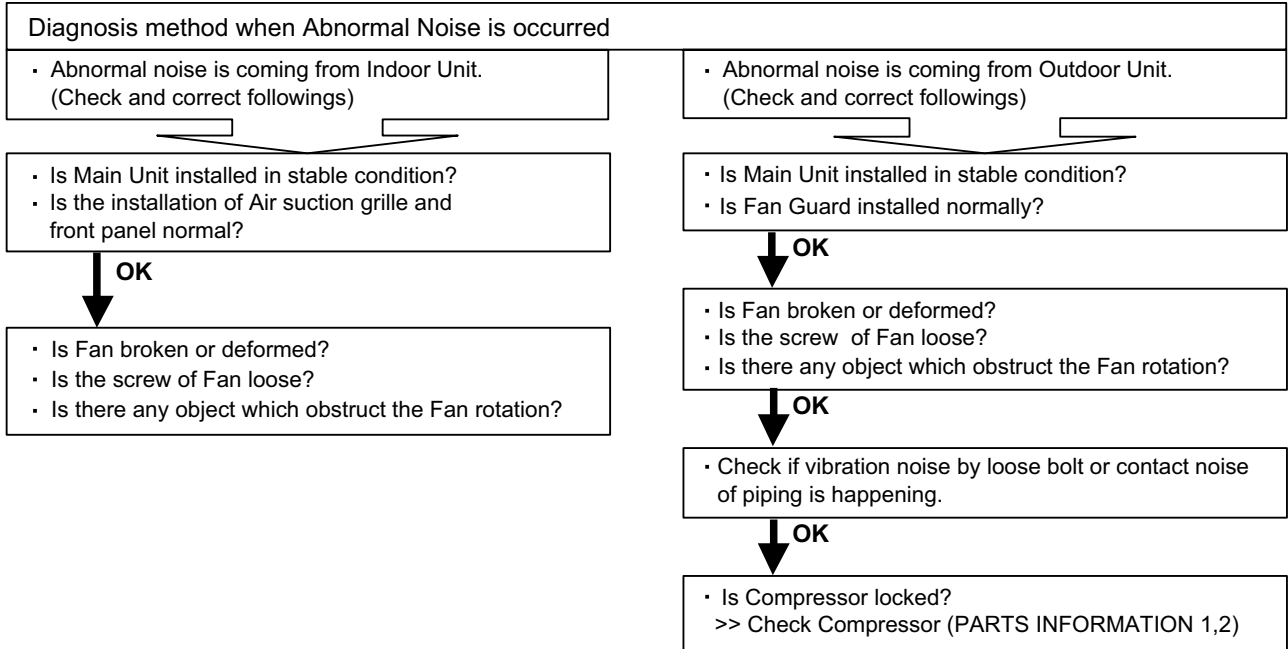

**Trouble shooting 25**  
Water Leaking

Forecast of Cause:  
1. Erroneous installation 2. Drain hose failure

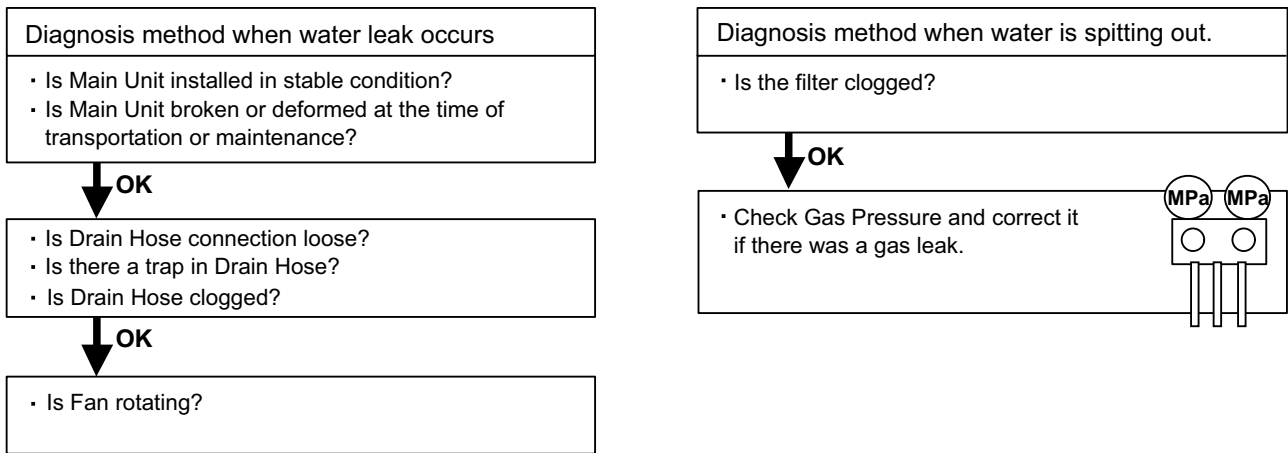

## 2-4 SERVICE PARTS INFORMATION

### SERVICE PARTS INFORMATION 1

#### Compressor

Diagnosis method of Compressor ( If Outdoor Unit LED displays Error, refer to Trouble shooting )

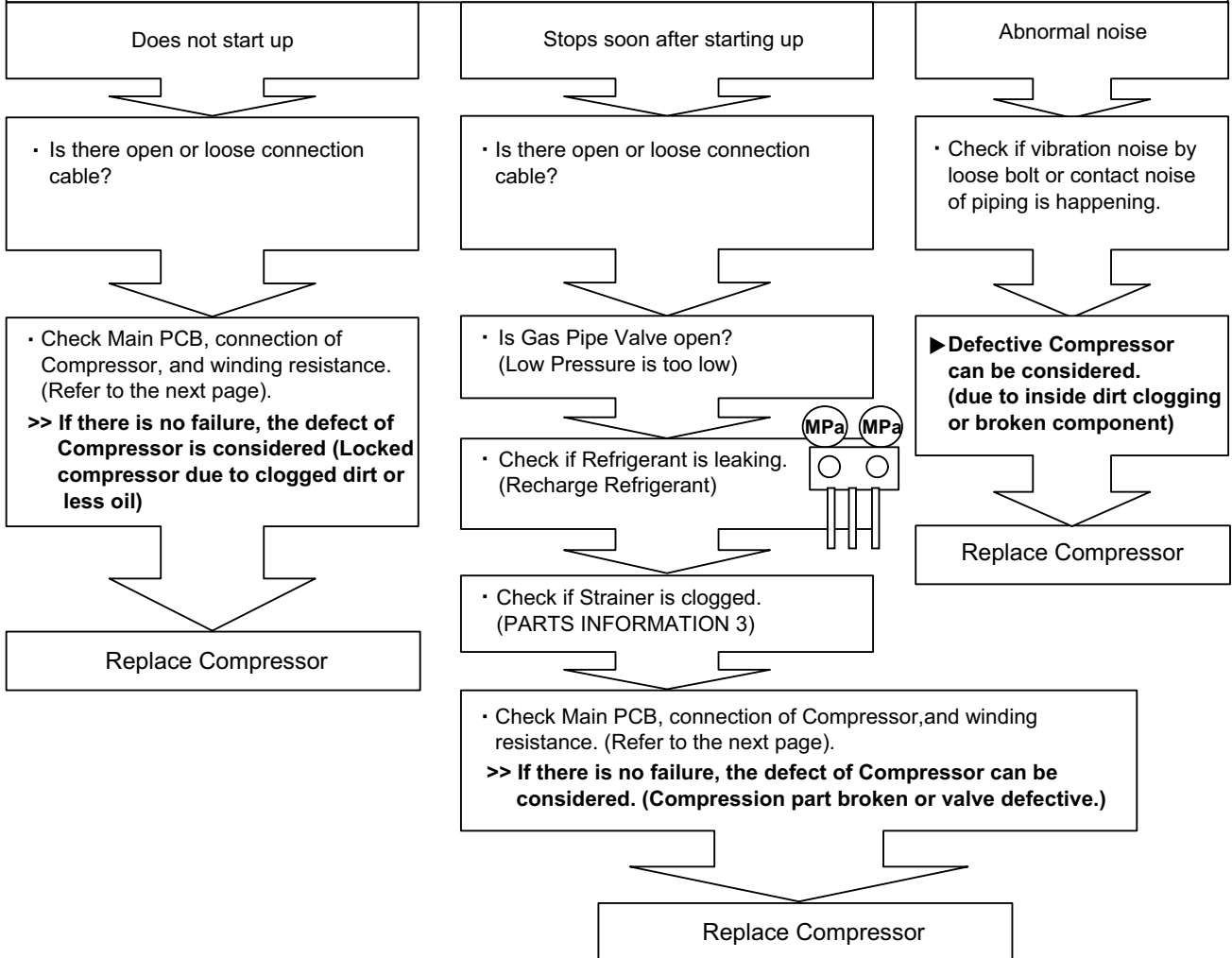

## SERVICE PARTS INFORMATION 2

### Inverter Compressor

#### Check Point 1 : Check Connection

- Check terminal connection of Compressor (loose or incorrect wiring)

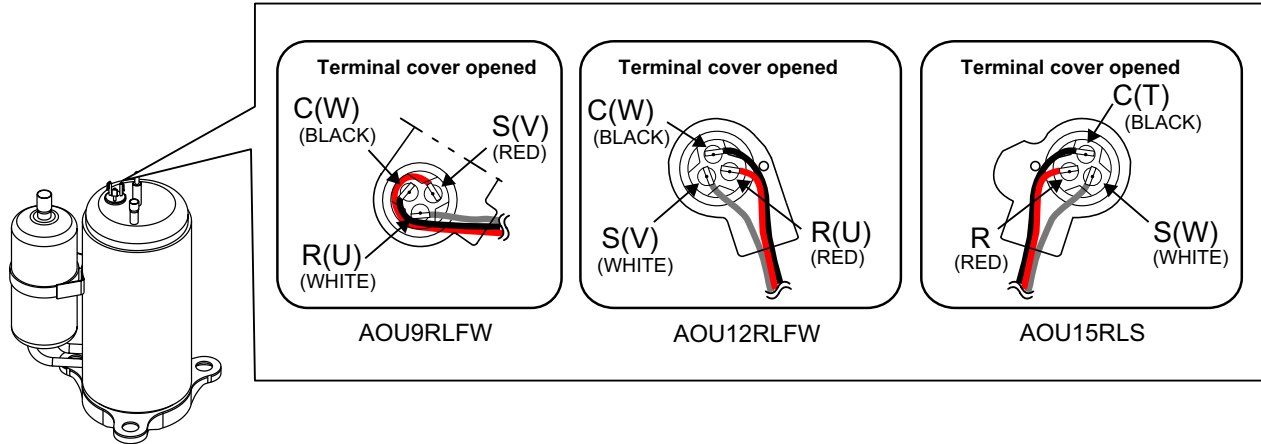

#### Check Point 2 : Check Winding Resistance

- Check winding resistance of each terminal

► **If the resistance value is 0Ω or infinite, replace Compressor.**

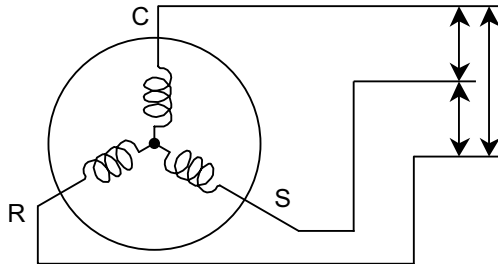

- **AOU9RLF**  
Resistance Value :  
2.7Ω at 20°C
- **AOU12RLF**  
Resistance Value :  
0.7Ω at 20°C
- **AOU15RLS**  
Resistance Value :  
1.4Ω at 25°C

#### Check Point 3 : Replace Main PCB

► **If the symptom does not change with above Check 1, 2, replace Main PCB.**

### SERVICE PARTS INFORMATION 3

Outdoor unit Electronic Expansion Valve  
( EEV )

#### Check Point 1 : Check Connections

- Check connection of connector (CN40)  
( Loose connector or open cable )

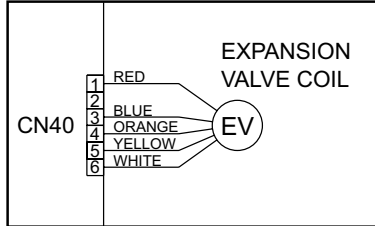

#### Check Point 2 : Check Coil of EEV

- Remove connector, check each winding resistance of Coil.

Read wire	Resistance value
White - Red	$46 \Omega \pm 4 \Omega$ at 20°C
Yellow - Red	
Orange - Red	
Blue - Red	



► **If Resistance value is abnormal, replace EEV.**

#### Check Point 3 : Check Voltage from Main PCB.

- Remove Connector and check Voltage (DC12V)

► **If it does not appear, replace Main PCB.**

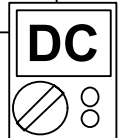

#### Check Point 4 : Check Noise at start up

- Turn on Power and check operation noise.

► **If an abnormal noise does not show, replace Main PCB.**

#### Check Point 5 : Check Opening and Closing Operation of Valve

When Valve is closed,  
it has a temp. difference between Inlet and Outlet.

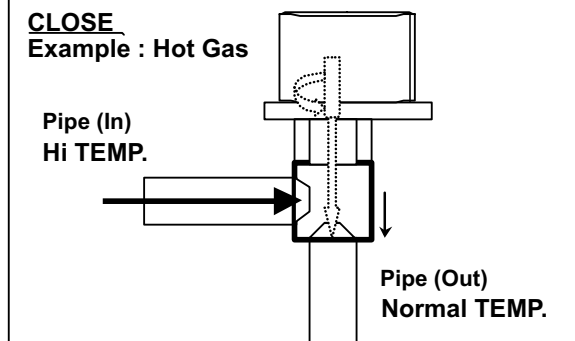

If it is open,  
it has no temp. difference between Inlet and Outlet.

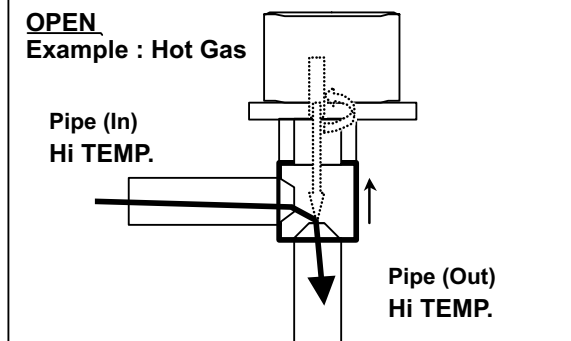

#### Check Point 6 : Check Strainer

Strainer normally does not have temperature difference between inlet and outlet as shown in ①, but if there is a difference as shown in ②, there is a possibility of inside clogged. In this case, replace Strainer.

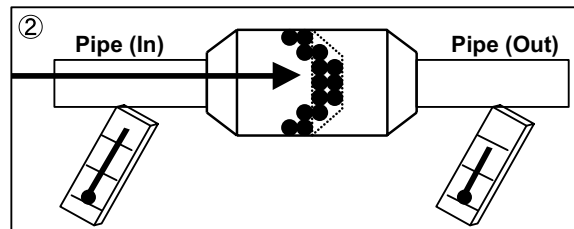
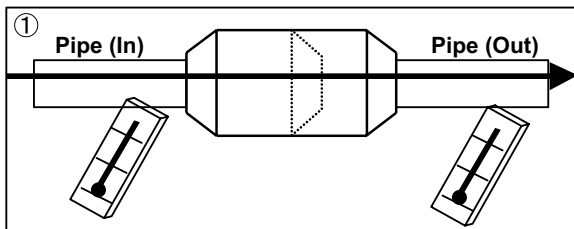

#### SERVICE PARTS INFORMATION 4

Indoor unit fan motor

Check Point 1 : Check rotation of Fan

- Rotate the fan by hand when operation is off.  
(Check if fan is caught, dropped off or locked motor)
- >>If Fan or Bearing is abnormal, replace it.**

Check Point 2 : Check resistance of Indoor Fan Motor

- Refer to below. Circuit-test "Vm" and "GND" terminal.  
(Vm: DC voltage, GND: Earth terminal)
- >>If they are short-circuited (below 300 k $\Omega$ ), replace Indoor fan motor and Controller PCB.**

Pin number (wire color)	Terminal function (symbol)
1 (Blue)	Feed back (FG)
2 (Yellow)	Speed command (Vsp)
3 (White)	Control voltage (Vcc)
4 (Black)	Earth terminal (GND)
5	No function
6 (Red)	DC voltage (Vm)

---

#### SERVICE PARTS INFORMATION 5

Outdoor unit fan motor

Check Point 1 : Check rotation of Fan

- Rotate the fan by hand when operation is off.  
(Check if fan is caught, dropped off or locked motor)
- >>If Fan or Bearing is abnormal, replace it.**

Check Point 2 : Check resistance of Outdoor Fan Motor

- Refer to below. Circuit-test "Vm" and "GND" terminal.  
(Vm: DC voltage, GND: Earth terminal)
- >>If they are short-circuited (below 300 k $\Omega$ ), replace Outdoor fan motor and Main PCB.**

Pin number (wire color)	Terminal function (symbol)
1 (Red)	DC voltage (Vm)
2	No function
3	No function
4 (Black)	Earth terminal (GND)
5 (White)	Control voltage (Vcc)
6 (Yellow)	Speed command (Vsp)
7 (Brown)	Feed back (FG)

# ***WALL MOUNTED type INVERTER***

## **3 . APPENDING DATA**

## 3-1. FUNCTION SETTING

### 3-1-1 INDOOR UNIT

- Follow the instructions in the Local Setup Procedure, which is supplied with the remote control, in accordance with the installed condition.  
After the power is turned on, perform the Function Setting on the remote control.
- The settings may be selected between the following two: Function Number or Setting Value.
- Settings will not be changed if invalid numbers or setting values are selected.

#### 1-1. Setting the Filter Sign

The indoor unit has a sign to inform the user that it is time to clean the filter.

Select the time setting for the filter sign display interval in the table below according to the amount of dust or debris in the room.

If you do not wish the filter sign to be displayed, select the setting value for "No indication".

(◆ . . . Factory setting)

Setting Description	Function Number	Setting Value
Standard (400 hours)	11	00
Long interval (1000 hours)		01
Short interval ( 200 hours)		02
◆ No indication		03

#### 1-2. Setting the Cooler Room Temperature Correction

Depending on the installed environment, the room temperature sensor may require a correction. The settings may be selected as shown in the table below.

(◆ . . . Factory setting)

Setting Description	Function Number	Setting Value
◆ Standard	30	00
Slightly lower control		01
Lower control		02
Warmer control		03

#### 1-3. Setting the Heater Room Temperature Correction

Depending on the installed environment, the room temperature sensor may require a correction. The settings may be selected as shown in the table below.

(◆ . . . Factory setting)

Setting Description	Function Number	Setting Value
◆ Standard	31	00
Lower control		01
Slightly warmer control		02
Warmer control		03

#### 1-4. Setting the Auto Restart

Enable or disable automatic system restart after a power outage.

(◆ . . . Factory setting)

Setting Description	Function Number	Setting Value
◆ Yes	40	00
No		01

#### 1-5. Setting the Indoor room temperature sensor switching function (Only for Wired remote controller)

The following settings are needed when use the control by  
Wired remote controller temperature sensor.

(◆ . . . Factory setting)

Setting Description	Function Number	Setting Value
◆ No	42	00
Yes		01

\* If setting value is "00" : Room temperature is controlled by the indoor unit temperature sensor.

\* If setting value is "01" : Room temperature is controlled by remote controller unit sensor.

#### 1-6. Setting the Remote controller signal code

Change the indoor unit Signal Code, depending on the remote controllers.

(◆ . . . Factory setting)

Setting Description	Function Number	Setting Value
◆ A	44	00
B		01
C		02
D		03

#### 1-7. Setting the External input control

"Operation/Stop" mode or "Forced stop" mode can be elected.

(◆ . . . Factory setting)

Setting Description	Function Number	Setting Value
◆ Operation/Stop mode	46	00
(Setting forbidden)		01
Forced stop mode		02



## 3-1-2 Procedures to change the Function Setting for wireless RC

- This procedure changes to the function settings used to control the indoor unit according to the installation conditions. Incorrect settings can cause the indoor unit malfunction.
- After the power is turned on, perform the "FUNCTION SETTING" according to the installation conditions using the remote controller.
- Settings will not be changed if invalid numbers or setting values are selected.

### Entering the Function Setting Mode

- While pressing the FAN button and SET TEMP.(▲) simultaneously, press the RESET button to enter the function setting mode.



### Selecting the Function Number and Setting Value

- (1) Press the MODE button, and proceed to Function Number and Setting Value.  
(There is no necessity for setting remote control signal code. Because signal code is setting by Function Number and Setting Value.)

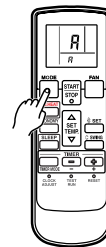

- (2) Press the SET TEMP. (▲) (▼) buttons to select the Function Number.  
(Press the MODE button to switch between the left and right digits.)
- (3) Press the FAN button to proceed to Setting Value.  
(Press the FAN button again to return to the Function Number selection.)
- (4) Press the SET TEMP. (▲) (▼) buttons to select the Setting Value.  
(Press the MODE button to switch between the left and right digits.)

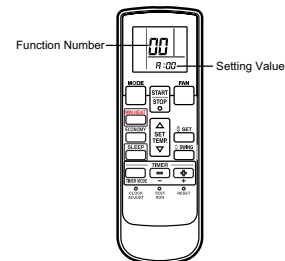

- (5) Press the TIMER MODE button. It makes a signal to indoor unit.  
(Indoor unit recognize the setting.)
- (6) Press the START/STOP button. It makes a signal to indoor unit.  
(Indoor unit run the setting.)

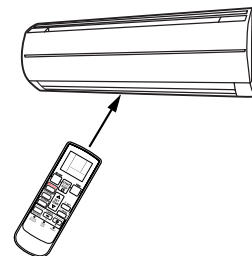

- (7) Press the RESET button to cancel the function setting mode.
- (8) After completing the FUNCTION SETTING, be sure to turn of the power and turn it on again.



#### ⚠ CAUTION

After turning off the power, wait 10 seconds or more before turning on it again.  
The FUNCTION SETTING doesn't become effective if it doesn't do so.

## Custom code setting for remote controller

- (1) Press the MODE button for more than 5 seconds.
- (2) Press the SET TEMP. (▲) (▼) buttons to change the signal code between  $A \rightarrow b \rightarrow c \rightarrow d$ .  
Match the code on the display to the air conditioner signal code. (initially set to  $A$ )
- (3) Press the MODE button. (Return to normal display)

### CAUTION

If you change the setting of Function Number and Setting Value after setting custom code in remote controller, please set custom code in remote controller again.

The remote control unit resets to signal code A when the batteries in the remote control unit are replaced. If you use a signal code other than signal code A, reset the signal code after replacing the batteries.

If you do not know the air conditioner signal code setting, try each of the signal codes (  $A \rightarrow b \rightarrow c \rightarrow d$  ) until you find the code which operates the air conditioner.

## 3-2. Thermistor Resistance Values

### 3-2-1 INDOOR UNIT

Room temperature thermistor		
Temp (°C)	Resistance(kΩ)	Voltage(V)
-10.0	58.2	0.73
-5.0	44.0	0.93
0.0	33.6	1.15
5.0	25.9	1.39
10.0	20.2	1.66
15.0	15.8	1.94
20.0	12.5	2.22
25.0	10.0	2.50
30.0	8.0	2.77
35.0	6.5	3.03
40.0	5.3	3.27
45.0	4.4	3.49

Indoor heat exchanger thermistor		
Temp (°C)	Resistance(kΩ)	Voltage(V)
-30.0	1131.9	0.21
-25.0	804.5	0.29
-20.0	579.6	0.40
-15.0	422.9	0.53
-10.0	312.3	0.69
-5.0	233.2	0.88
0.0	176.0	1.10
5.0	134.2	1.36
10.0	103.3	1.63
15.0	80.3	1.92
20.0	62.9	2.21
25.0	49.7	2.51
30.0	39.6	2.79
35.0	31.7	3.06
40.0	25.6	3.30
45.0	20.8	3.53
50.0	17.1	3.73
55.0	14.1	3.90
60.0	11.6	4.05
63.0	10.4	4.14

### 3-2-2 OUTDOOR UNIT

Discharge thermistor		
Temp (°C)	Resistance(kΩ)	Voltage(V)
-30.0	1013.1	0.06
-25.0	729.1	0.09
-20.0	531.6	0.12
-15.0	392.3	0.16
-10.0	292.9	0.21
-5.0	221.1	0.28
0.0	129.8	0.46
5.0	134.2	1.36
10.0	100.9	0.57
15.0	79.1	0.71
20.0	62.6	0.86
25.0	49.8	1.03
30.0	40.0	1.23
35.0	32.4	1.43
40.0	26.3	1.65
45.0	21.6	1.88
50.0	17.8	2.11
55.0	14.8	2.34
60.0	12.3	2.57
65.0	10.3	2.79
70.0	8.7	3.00
75.0	7.4	3.19
80.0	6.3	3.37
85.0	5.4	3.54
90.0	4.6	3.69
95.0	4.0	3.83
100.0	3.4	3.96
105.0	3.0	4.07
110.0	2.6	4.17
115.0	2.3	4.26
120.0	2.0	4.33

Outdoor heat exchanger thermistor		
Temp (°C)	Resistance(kΩ)	Voltage(V)
-30.0	95.6	0.24
-25.0	68.9	0.32
-20.0	50.3	0.43
-15.0	37.2	0.57
-10.0	27.8	0.73
-5.0	21.0	0.92
0.0	16.1	1.14
5.0	12.4	1.39
10.0	9.6	1.65
15.0	7.6	1.93
20.0	6.0	2.21
25.0	4.8	2.49
30.0	3.8	2.77
35.0	3.1	3.02
40.0	2.5	3.26
45.0	2.1	3.48
50.0	1.7	3.68
55.0	1.4	3.85
60.0	1.2	4.00
65.0	1.0	4.13
70.0	0.8	4.25
75.0	0.7	4.35
80.0	0.6	4.43

Outdoor temperature thermistor		
Temp (°C)	Resistance(kΩ)	Voltage(V)
-30.0	224.3	0.73
-25.0	159.7	0.97
-20.0	115.2	1.25
-15.0	84.2	1.56
-10.0	62.3	1.90
-5.0	46.6	2.26
0.0	35.2	2.61
5.0	26.9	2.94
10.0	20.7	3.25
15.0	16.1	3.52
20.0	12.6	3.76
25.0	10.0	3.97
30.0	8.0	4.14
35.0	6.4	4.28
40.0	5.2	4.41
45.0	4.2	4.51
50.0	3.5	4.59
55.0	2.8	4.65



## **FUJITSU GENERAL LIMITED**

---

1116, Suenaga, Takatsu-ku, Kawasaki 213-8502, Japan